

Experimental Demonstration of IDMA-OFDM for Visible Light Communications

Bangjiang Lin^{1*}, Xuan Tang^{1*}, Xiaohuan Shen¹, Haiguang Zhang¹, Yi Wu², Hui Li² and Zabih Ghassemlooy³

¹ Quanzhou Institute of Equipment Manufacturing, Haixi Institutes, Chinese Academy of Sciences, Fujian, China;

² Key Laboratory of OptoElectronic Science and Technology for Medicine of Ministry of Education, Fujian Normal University, China

³ Optical Communications Research Group, Faculty of Engineering and Environment, Northumbria University, Newcastle, U.K.

*linbangjiang@163.com, xtang@fjirsm.ac.cn

Abstract: We experimentally demonstrate a multicarrier interleave division multiple access (IDMA) scheme for bidirectional visible light communications (VLC) using orthogonal frequency division multiplexing (OFDM), which has the advantages of good tolerance against multi-path, high spectral efficiency and excellent transmission performance. The generated IDMA signals are modulated on OFDM subcarriers and the different users are separated by the interleavers. When compared with OFDMA, IDMA-OFDM offers increased transmission spans of 30 cm and 50 cm at a BER of 10^{-3} in the cases of 2 and 4 users, respectively.

1. Introduction

Light emitting diode (LED) has been widely deployed in our daily life, such as car and traffic light, indoor illumination, owing to its low power consumption, high security, long life, and environmental protection. In recent years, visible light communications (VLC) based on the LED as a promising candidate to complement the conventional radio frequency (RF) wireless technology has attracted much interest from industry and academic, which offers the advantages of license-free, low cost, and easy integration with pervasive illustration devices [1-5]. We are now witnessing a revolution in wireless technology where VLC based Light Fidelity (LiFi) emerges as one potential candidate to support more than 1Gbps data rate [6]. In the standard process of LiFi, many issues such as modulation format, channel model, multiple access (MA) schemes in physical layer should be well studied.

Most of the MA schemes in wireless communication such as time division multiple access (TDMA), frequency division multiple access (FDMA), code division multiple access (CDMA) and orthogonal frequency domian multiple access (OFDMA) have already been widely investigated for indoor VLC [7-9]. OFDMA has high spectrum efficiency and system capacity, which has been adopted for the fourth generation wireless communications and also widely investigated as a promising technique for coherent optical communications and passive optical network [10-13]. The multiple access interference (MAI) and inter-symbol interference limit the system capacity of CDMA [14], which can be easily removed for OFDMA.

However, the OFDMA signal has a high peak-to-average ratio (PAPR), which degrades the transmission performance due to nonlinear distortion. In [15], the interleaved frequency division multiple access (IFDMA) as a modified OFDMA scheme has been applied for VLC to achieve a better performance due to its low PAPR. In [16], a

non-orthogonal multiple access (NOMA) scheme using OFDMA is investigated as a good solution to increase the spectrum efficiency and the supported users for VLC . In [17], an interleave division multiple access (IDMA) scheme for bidirectional VLC transmission was proposed and experimentally demonstrated, which offered high robustness against multiple access interference and burst error .

In this paper, we investigate the multicarrier IDMA scheme (i.e. IDMA-OFDM) as a promising MA scheme for bidirectional VLC with experimental demonstration. The IDMA-OFDM scheme incorporates both the advantages of IDMA and OFDM, such as good tolerance to multi path and burst error and high spectrum efficiency. The IDMA-OFDM based VLC systems have already been investigated based on simulation [18-19]. To the best of our knowledge, this is the first work provides the experimental verification of the feasibility of IDMA-OFDM based VLC system. Our experimental results show that IDMA-OFDM provides excellent transmission performance. When compared with OFDMA, IDMA-OFDM offers increased transmission spans of 30 cm and 50 cm at a BER of 10^{-3} in the cases of 2 and 4 users, respectively.

The rest of the paper is outlined as follows. Section 2 describes the VLC system based on IDMA-OFDM in detail. Section 3 presents the experiment setup and results for IDMA-OFDM-VLC. Section 4 draws the conclusions.

2. IDMA-OFDM scheme

Figure 1 shows the system architecture for downlink IDMA-OFDM-VLC with K users. In the transmitter (Tx), for each user a spreader is used to expand the bandwidth of the source data ($d_k, k=1, 2, \dots, K$). A unique interleaver (π_k) is used to scatter the data on k^{th} user randomly. Moreover, burst error control can be also achieved using the interleaver. Note that the interleavers can separate different users. The interleaved bits are usually called chips. After interleaving, the chips from all users ($x_k, k=1, 2, \dots, K$) are combined

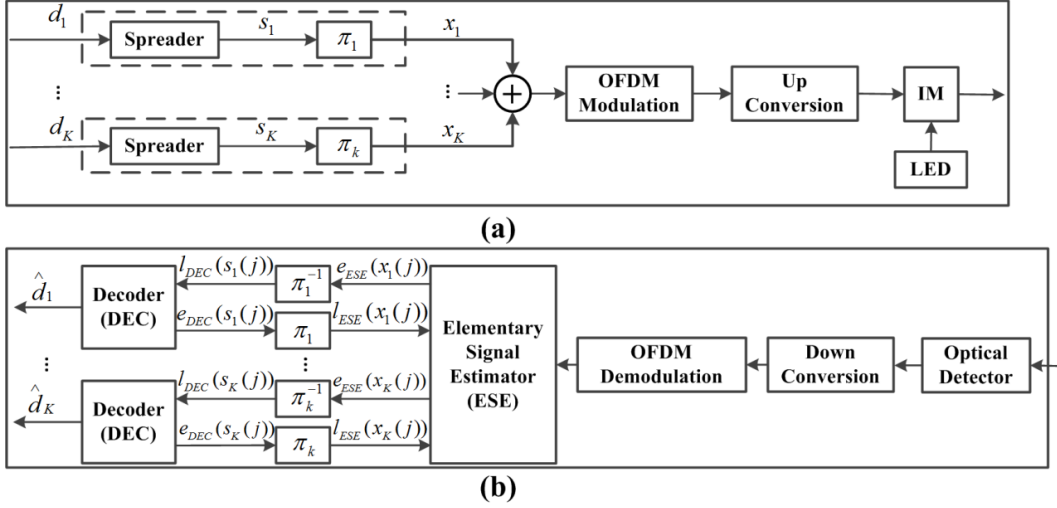

Fig. 1 Block diagram of (a) transmitter and (b) receiver for downlink IDMA-OFDM-VLC.

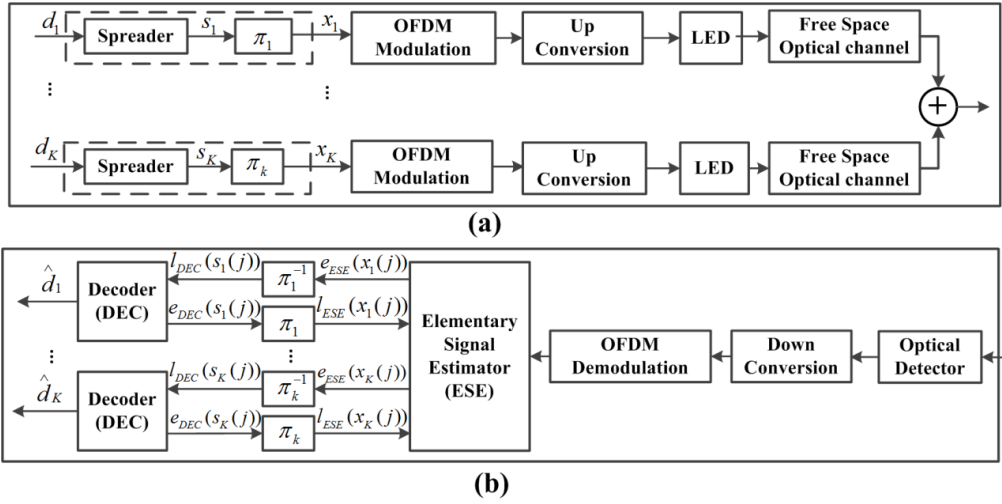

Fig. 2 Block diagram of (a) transmitter and (b) receiver for uplink IDMA-OFDM-VLC.

together. Then the combined IDMA signal is fed into the OFDM modulation module. In order to combat multi-path and perform channel estimation, we insert cyclic prefix (CP) and training sequences in each OFDM symbol and the front head of each frame, respectively. Since the input of the LED should be a real-value and positive signal, the baseband OFDM signal is up-converted to a RF subcarrier and then a direct current (DC) bias is added prior to intensity modulation (IM). The output of the LED is passed through a free-space channel. At the receiver (Rx), the optical IDMA-OFDM signal is detected by a photo detector. After down conversion, the baseband OFDM signal is frame synchronized firstly and then fed into the OFDM demodulation module, which performs CP removal as well as channel estimation and equalization. The recovered IDMA signal is fed into the IDMA demodulation module with iterative decoding. The decoded signal with perfect channel equalization before the IDMA decoding module can be expressed as:

$$r(j) = \sum_{k=1}^K x_k(j) + n(j), \quad (1)$$

in which $n(j)$ is the noise term. The elementary signal estimator (ESE) calculates the extrinsic log-likelihood ratios (ELLRs) of all users. The ELLRs can be expressed as:

$$e_{ESE}(x_k(j)) = 2 \frac{r(j) - E(r(j)) + E(x_k(j))}{\text{Var}(r(j)) - \text{Var}(x_k(j))} \quad (k = 1, 2, \dots, K). \quad (2)$$

The following equations are used to calculate the variances and mean values in (2):

$$E(x_k(j)) = \tanh[l_{ESE}(x_k(j)) / 2], \quad (3)$$

$$\text{Var}(x_k(j)) = 1 - (E(x_k(j)))^2, \quad (4)$$

$$E(r(j)) = \sum_{k=1}^K E(x_k(j)), \quad (5)$$

$$\text{Var}(r(j)) = \sigma^2 + \sum_{k=1}^K \text{Var}(x_k(j)). \quad (6)$$

For k^{th} user, the ELLR is firstly de-interleaved using π_k^{-1} , the output of which is the priori log-likelihood ratio (PLLr) $l_{DEC}(s_k(j))$ of the posterior probability decoder (DEC). The DEC outputs the transmitted data bits and the ELLR of DEC $e_{DEC}(s_k(j))$ for k^{th} user. In the next iterative decoding process, $e_{DEC}(s_k(j))$ is fed into the unique interleave of k^{th} user (i.e. π_k), the output of which $l_{ESE}(x_k(j))$ is the PLLr of ESE. The ESE updates the ELLR $e_{ESE}(x_k(j))$ using its PLLRs for further processing. When the IDMA decoding module performs N -iterations, the data bits of all users are achieved. N is the number of iterations we set, which should be optimized in the experiment. For each iteration, the

required interleaving and de-interleaving operation times are both 1 per user. And two tanh operations and two multiplications are required for each user.

Figure 2 shows the system architecture of uplink IDMA-OFDM-VLC. The IDMA signal for each user is generated firstly and then converted into OFDM symbols. CP and preamble are inserted before up-conversion to a RF subcarrier. For each user, the transmitted IDMA-OFDM signal is intensity modulated on a LED, respectively. After transmission in the free space, the optical IDMA-OFDM signals from K TxS are captured by a single photo detector. After down-conversion and OFDM de-modulation, the IDMA signal is fed into the IDMA demodulation module, which also performs iterative decoding. The signal processing module for uplink is similar with that for downlink. Note that the IDMA signals are combined at the Rx in optical domain for uplink, while they are combined at the Tx in digital domain for downlink.

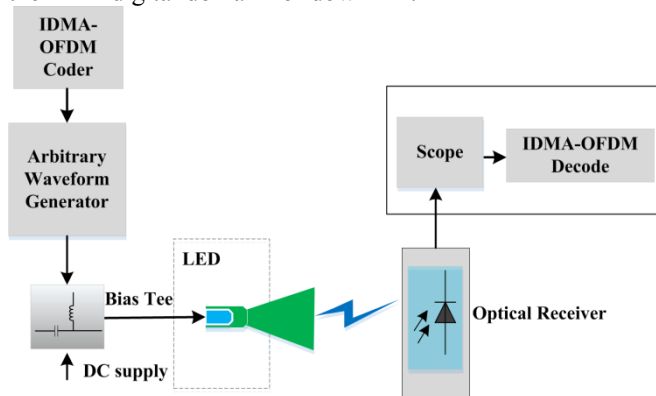

Fig. 3. Experimental setup for downlink IDMA-OFDM-VLC.

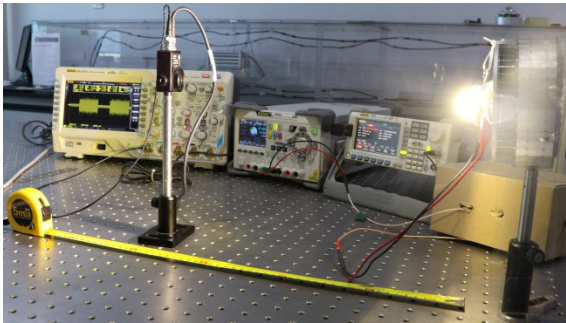

Fig. 4. Photograph of the actual experiment setup for downlink..

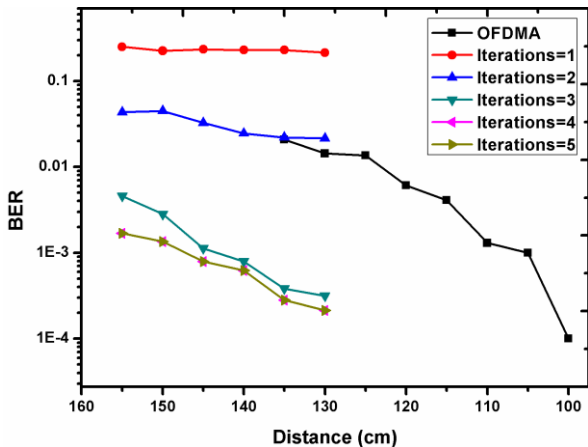

Fig. 5. BER performance for OFDMA and IDMA-OFDM downlink VLC with 2 users.

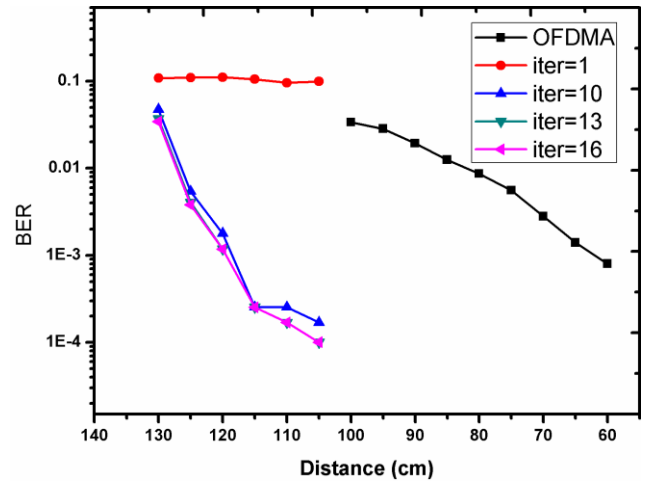

Fig. 6. BER performance for OFDMA and IDMA-OFDM downlink VLC with 4 users.

3. Experimental setup and results

The experimental setup of downlink VLC based on IDMA-OFDM is shown in Fig. 3. Fig. 4 shows the real experimental platform. For each user, the transmitted signal is generated as shown in Fig. 1 (a) with a bitrate of 3.3 Mb/s. The transmitted IDMA signals are combined directly in the Matlab and then fed into the OFDM modulation module, the output of which is up-sampled three times before up-conversion to a subcarrier with a frequency of 2.5 MHz. The digital IDMA-OFDM signal is then fed into an arbitrary waveform generator (AWG) with a sample rate of 10 MS/s. The total number of the SCs employed for data transmission is 128 and the CP size is 4. The output of the AWG combined with a direct current (DC) through a bias-Tee module and then loaded into the LED. In the receiver side, the optical IDMA-OFDM is converted into the electrical signal by a photodiode and recorded on a real time scope with a sample rate of 50 MS/s. The captured signal is fed into the demodulation module shown in Fig.1 (b). A downlink VLC system based on the OFDMA is also considered here for comparison. Quadrature phase shift keying (QPSK) and 16- quadrature amplitude modulation (QAM) are used when the user numbers are 2 and 4, respectively. This ensures the same bandwidths are used at the same bitrate for OFDMA and IDMA-OFDM. The DFT and CP sizes are 128 and 4, respectively. A RF carrier with a frequency of 2.5 MHz is also used to carrier the OFDM signal. The up-converted OFDMA signal combined with a DC bias is fed into the LED for IM. This ensures the input of the LED is a real-value and positive signal. The detail system parameters can be found in Table 1. All the key system parameters for OFDMA-VLC are provided in Table I. QPSK or 16QAM symbols are applied for IDFT operation in OFDMA, while the combined IDMA signal is used for IDFT operation in IDMA-OFDM. The total bitrates are 6.6Mb/s and 13.2Mb/s when the user numbers are 2 and 4, respectively.

The average BER performance as a function of the transmission span for both IDMA-OFDM- and OFDMA-VLC downlinks with two users and four users is shown in Figs. 5 and 6, respectively. Each BER is calculated from the average of the two users based on more than 1×10^6 binary bits. The BER is very high when the iterative number is 1. As the iterative number increases, the BER performance is

improved. The optimum iterations are 4 and 13 for IDMA-OFDM-VLC downlink with 2 and 4 users respectively beyond which there is no further improvement. Compared with OFDMA scheme, IDMA-OFDM offers increased transmission spans at the BER of 1×10^{-3} . The increased spans are about 30 cm and 50 cm for the cases of 2 and 4 users, respectively. Therefore, IDMA-OFDM offers better transmission performance than OFDMA due to the iterative operation. As the number of users increases, it is more difficult to eliminate the user interference. Therefore, more iterative operation is required for the case of 4 users compared with the case of 2 users.

Table I. System Parameters

Parameters	Value
AWG sampling rate	10 MS/s
Scope sampling rate	50 MS/s
Transmit optical power	~150 mW
LED bandwidth	~5 MHz
Pin photodetector	
Active area	13 mm ²
Responsivity	< 0.4 A/W
Bandwidth	10 MHz
Field of view	~90 °
IDMA-OFDM	
User number	2, 4
Bitrate per user	3.3 Mb/s
DFT size	128
CP size	4
RF carrier	2.5 MHz
OFDMA	
User number	2, 4
Bitrate per user	3.3 Mb/s
Modulation format	QPSK, 16QAM
DFT size	128
CP size	4
RF carrier	2.5 MHz

The experimental platform of uplink IDMA-OFDM-VLC with 2 users is shown in Fig. 7. For each user, the transmitted IDMA-OFDM signal is generated as shown in Fig. 2 (a) and then uploaded to the AWG, respectively. In order to synchronize the two Tx's, the two channel of the AWG should be operated at the same time. The bit rate for each user is 3.3 Mb/s. All the key parameters for OFDM modulation in the uplink is shown in Table 1, which similar with that in the downlink. The outputs of the AWG combined with a DC bias are used to drive two LEDs, respectively. The transmitted optical power and the bandwidth of the LED are about 150 mw and 5 MHz. Note that the bitrate of the IDMA-OFDM signal can be improved using a LED with a greater bandwidth. The bandwidth of the LED can be improved with pre- and post-equalization techniques. After free-space transmission, the two optical signals are detected simultaneously by a commercial photo detector. The detected signal is captured by a real-time digital oscilloscope and then offline processed by Matlab to decode the IDMA-OFDM signal as shown in Fig. 2 (b). The sampling rate of the scope is 50 MS/s.

The BER performance of each user against the transmission span for uplink IDMA-OFDM-VLC is shown in Fig. 8. The optical Rx is placed in the middle of the two users. If the optical Rx is not placed in the middle of the two

Txs, the user which is more close to the Rx can achieve better BER performance. As shown in Fig. 8, the transmission distances at a BER of 10^{-3} are 116 and 118 cm for user 1 and user 2, respectively. Note that if a lens is placed in the front of Rx, more optical power can be concentrated into the photo detector. As such, a longer transmission distance can be achieved for IDMA-OFDM VLC.

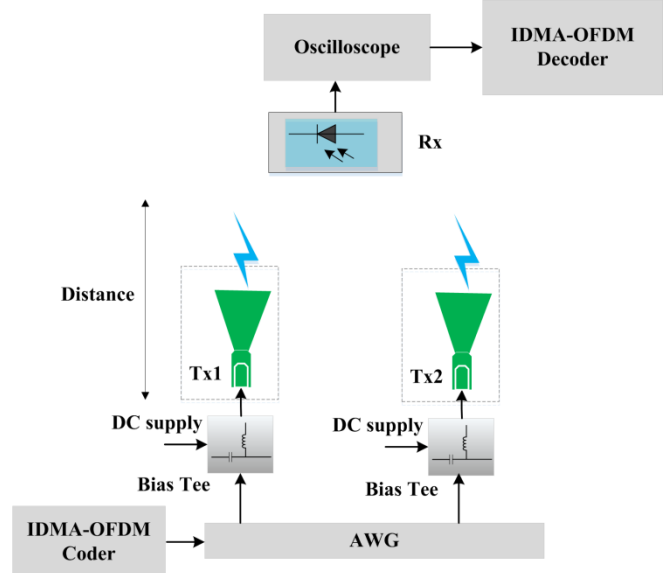

Fig. 7. Experimental setup for uplink IDMA-OFDM-VLC.

Fig. 9 shows the BER performance as a function of data rate in the downlink transmission. Note that the number of users and iterations are 4 and 13, respectively. A lens is placed in the front of the optical Rx and the transmission distance is 2m. Since the 3 dB bandwidth of the LED is about 5 MHz, the BER performance is deteriorated as the data rate increases. We can improve the transmission performance by using the equalizers both at the Tx and Rx to expand the bandwidth of the LED.

4. Conclusions

In this paper, we experimentally demonstrated an IDMA-OFDM based VLC system, in which the IDMA signal were carried on OFDM SCs and different users were distinguished by the interleavers. The experiment results revealed that the IDMA-OFDM offered better BER performance than OFDMA for VLC systems. The proposed scheme was proved to be a promising MA scheme for bidirectional VLC, because of its good tolerance against multi path and improved transmission performance.

5. Acknowledgments

This work was supported in part by the National Science Foundation of China under Grants 61601439, 61571128 and 61501427, in part by the Chunmiao Project of Haixi Institutes, Chinese Academy of Sciences, in part by Fujian Science Foundation under Grant 2017J05111, in part by External Cooperation Program of Chinese Academy of Sciences under Grant 121835KYSB20160006, in part by Development of Scientific Research Instrument of Chinese Academy of Sciences under Grant YJKYYQ20170052, in part by Program of Quanzhou Science and Technology under Grant 2016G007 and 2016T010, in part by State Key

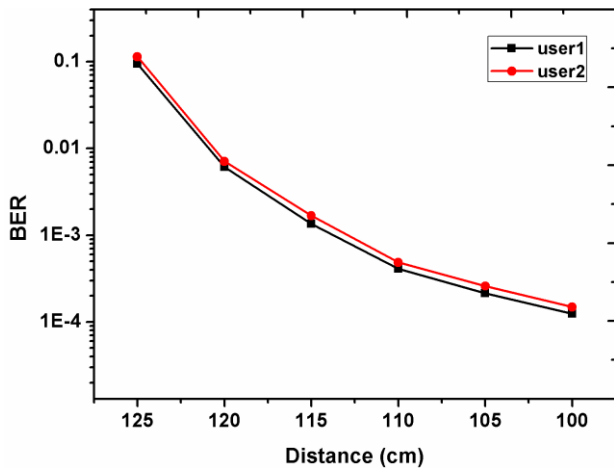

Fig. 8. BER performance for uplink IDMA-OFDM-VLC in the case of 2 users.

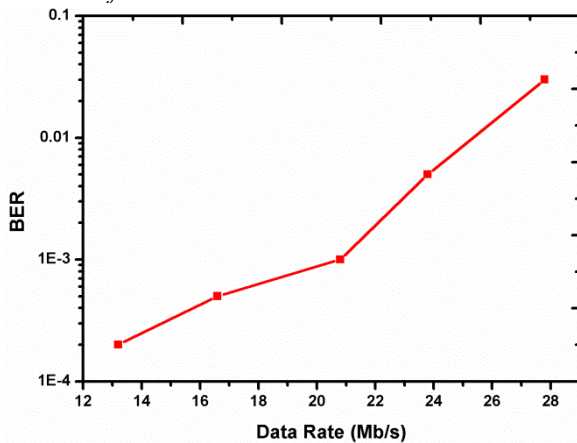

Fig. 9. BER performance for downlink IDMA-OFDM-VLC with a propagation distance of 2m and 4 users.

6. References

[1] Jovicic, A., J. Li, and T. Richardson.: ‘Visible light communication: opportunities, challenges and the path to market’, *IEEE Communications Magazine*, 2013, 51, (12), pp:26-32.

[2] Grobe, L., Anagnostis P., Jonas Hilt, Dominic Schulz, Friedrich Lassak, et al.: ‘High-speed visible light communication systems’, *IEEE Communications Magazine*, 2013, 51, (12), pp:60-66.

[3] Bangjiang Lin, Xuan Tang, Zabih Ghassemlooy, Xi Fang, Chun Lin, Yiwei Li, Shihao Zhang.: ‘Experimental Demonstration of OFDM/OQAM Transmission for Visible Light Communications’, *IEEE Photonics Journal*, 2016, 8, (5), pp:7906710.

[4] Bangjiang Lin, Xuan Tang, Zabih Ghassemlooy, Shihao Zhang, Yiwei Li.: ‘Efficient Frequency Domain Channel Equalization Methods for OFDM Visible Light Communications’, *IET Communication*, 2017, 11, (1), pp. 25–29.

[5] Bangjiang Lin, Zabih Ghassemlooy, Chun Lin, Xuan Tang, Yiwei Li, and Shihao Zhang.: ‘An Indoor Visible Light Positioning System Based on Optical Camera Communications’, *IEEE Photonics Technology Letters*, 2017, 29, (7), pp:579-582.

[6] Li-Fi Consortium. <http://lificonsortium.com/index.html>.

[7] O. Bouchet et al.: ‘ICT-213311 OMEGA: deliverable D4.3 optical wireless MAC specification’, November 2009, <http://www.ict-omega.eu/publications/deliverables.html> (October 2013).

[8] Jiun-Yu Sung, Chien-Hung Yeh, Chi-Wai Chow, Wan-Feng Lin, Yang Liu, ‘Orthogonal frequency-division multiplexing access (OFDMA) based wireless visible light communication (VLC) system,’ *Optics Communications*, 2015, 355, 261–268.

[9] Chi-Wai Chow, Chien-Hung Yeh, Yang Liu, Chin-Wei Hsu, and Jiun-Yu Sung, ‘Network Architecture of Bidirectional Visible Light Communication and Passive Optical Network,’ *IEEE Photonics Journal*, 2016, 8(3), 7904506.

[10] Bangjiang Lin, Juhao Li, Hui Yang, Yangsha Wan, Yongqi He, Zhangyaun Chen.: ‘Comparison of DSB and SSB transmission for OFDM-PON’, *Journal of Optical Communications & Networking*, 2012, 4, (4), pp.1-3.

[11] Cheng Zhang, Juhao Li, Fan Zhang, Yongqi He, Hequan Wu and Zhangyuan Chen.: ‘Experimental demonstration of a single-carrier frequency division multiple address based PON (SCFDMA-PON) architecture’, *Opt. Express*, 2010, 18, (24), pp: 24556–24564.

[12] Yuanxiang Chen, Juhao Li, Paikun Zhu, Yingying Xu, Yongqi He, Zhangyuan Chen.: ‘Experimental Demonstration of 1.2-Tb/s Optical PDM SCFDM Superchannel Multicasting by HNLF’, *IEEE Photonics Journal*, 2014, 5, (5), pp: 7902007.

[13] Bangjiang Lin, Juhao Li, Hui Yang, Song Jiang, Lixin Zhu, Yongqi He, and Zhangyuan Chen.: ‘Experimental Demonstration of Optical MIMO Transmission for SCFDM-PON Based on Polarization Interleaving and Direct Detection’, *Optics Communications*, 2012, 285, (24), pp: 5163–5168.

[14] Z. Zheng, Tec hen, Lu Liu, W. Hu., ‘Experimental demonstration of femtocell visible light communication system employing code division multiple access,’ in *Optical Fiber Communications Conf. and Exhibition, USA*, 2015, pp: 1–3.

[15] Bangjiang Lin, Xuan Tang, Hui Yang, Zabih Ghassemlooy, Shihao Zhang, Yiwei Li, and Chun Lin. ‘Experimental Demonstration of IFDMA for Uplink Visible Light Communication.’ *IEEE Photonics Technology Letters*, 2016, 28, (20), pp:2218-2220.

[16] Bangjiang Lin, Weiping Ye, Xuan Tang, and Zabih Ghassemlooy.: ‘Experimental demonstration of bidirectional NOMA-OFDMA visible light communications’, *Optics Express*, 2017, 25, (4), pp:4348-4354.

[17] Bangjiang Lin, Weiping Ye, Xuan Tang, and Zabih Ghassemlooy ‘Experimental demonstration of interleave division multiple access visible light communication’ *Optical Engineering*, 2017, 56, (5), pp: 056101.

[18] A. Kuriharat et al.: ‘An application of OFDM-IDMA to uplink multiusers VLC system,’ in *Int. Symp. on Intelligent Signal Processing and Communication Systems*, 2015, pp: 412–416.

[19] J. Dang and Z. Zhang.: ‘Comparison of optical OFDM-IDMA and optical OFDMA for uplink VLC’ in *Int. Conf. on Wireless Communications and Signal Processing*, 2012, pp. 1–6.