

Optical Power Domain NOMA for Visible Light Communications

Bangjiang Lin, Xuan Tang, and Zabih Ghassemlooy, *Senior Member, IEEE*

Abstract—We propose an optical power domain non-orthogonal multiple access (OPD-NOMA) scheme for visible light communications. OPD-NOMA superposes user messages in the optical power domain based on a light-emitting diode (LED) array. The maximum driven current for respective circuits is reduced compared to that of conventional NOMA, in which the LED-array-module is driven by a single circuit. OPD-NOMA reduces the gain and bandwidth requirements for the driver circuit of light source. The nonlinear power-current response of LED largely restricts its usable dynamic range and thus the transmit power. In OPD-NOMA, signals with lower powers suffer from reduced nonlinear distortion. The experimental results show that, OPD-NOMA offers improved transmission performance compared to conventional NOMA using the same driver circuit, since it can make a better use of the linear dynamic range of the LED's power-current response.

Index Terms—Visible light communications (VLC), successive interference cancellation (SIC), non-orthogonal multiple access (NOMA)

I. INTRODUCTION

VISIBLE light communications (VLC) is a potential solution for high-speed and short-range wireless communications [1]. However, the data rate offered by VLC is limited by the 3-dB bandwidth of light-emitting diode (LED). Non-orthogonal multiple access (NOMA) schemes are proposed to address this limitation [2-4]. In NOMA, multiplexing is carried out in the power domain (PD) or in the code domain by means of superposition coding, thus offering higher spectral efficiency compared to orthogonal multiple access (OMA). The PD-NOMA scheme is shown to be particularly suitable for short range (a few meters) VLC links with high signal to noise ratio (SNR) with a small number of users per cell [2]. It was shown extensively that NOMA

enhanced the system capacity compared to OMA for VLC [3, 4]. In [5, 6] the power allocation schemes were investigated for PD-NOMA-VLC in order to optimize the sum user rate. The experimental demonstrations of PD-NOMA-VLC were reported in [7, 8], whereas applications of PD-NOMA in MIMO-VLC were investigated [9, 10].

Although PD-NOMA based VLC offers a number of advantages, the gains expected from NOMA-VLC are limited by the inherent LED nonlinearity (i.e., power-current ($P-I$) response). The LED nonlinearity largely restricts the dynamic range and the transmit power of common optical transmitters (Tx) as well as the overall system performances. In VLC transmission systems, a relatively large current is needed to drive the LEDs. It is known that the product of gain and bandwidth is a constant for a driving amplifier. A larger current requires higher gain thus reduces the modulated bandwidth of the driver circuit. This also affects the overall system performance of NOMA-VLC. Equalization schemes such as hybrid time-frequency domain equalization and volterra-based nonlinear equalization were proposed to mitigate the LED's nonlinearity [11, 12]. In addition, the LED nonlinearity can be mitigated by adopting pre-distortion or post-distortion techniques [13, 14]. Note that, conventional optical Tx cannot provide the required linearity in a power- and cost-efficient way. On the other hand, multiple LEDs are usually utilized for more intense illumination due to the limited luminous flux of individual LED. In [15, 16], VLC systems using switchable LEDs were reported to overcome the LED's nonlinearity. A grouped modulation scheme was proposed to generate a multiple-level optical signal which reduced the gain-bandwidth product requirement for the driver circuit [17].

In this paper, we propose an optical power domain (OPD)-NOMA VLC scheme using a LED array, where LEDs are divided into a number of groups with each group being driven by a user with a particular driver circuit. The proposed scheme incorporates all the attractive features of conventional PD-NOMA such as improved fairness, higher system throughput compared to OMA. In addition (i) the bandwidth constraint of a high current driver circuit for high-power LEDs is suppressed; and (ii) the transmitted signals with lower power levels suffer from a reduced level of nonlinear distortion due to LED's $P-I$ characteristic and active electrical modules (i.e., amplifiers). In this work, we have developed an experimental testbed to verify the feasibility of the proposed scheme. We show that, OPD-NOMA offers improved performance in terms of the average bit error rate (BER) compared to conventional PD-NOMA using the same driver circuit with a limited gain-bandwidth product. This is because OPD-NOMA can make a better use of the linear dynamic range of the LED's $P-I$ response.

This work was supported in part by the National Science Foundation of China under Grant 61601439, in part by Fujian Science Foundation under Grant 2017J05111, in part by Development of Scientific Research Instrument of Chinese Academy of Sciences under Grant YJKYYQ20170052, in part by State Key Laboratory of Advanced Optical Communication Systems and Networks, China.

Bangjiang Lin, Xuan Tang are with Quanzhou Institute of Equipment Manufacturing, Haixi Institutes, Chinese Academy of Sciences, Quanzhou, China (e-mail: linbangjiang@fjirsm.ac.cn, xtang@fjirsm.ac.cn). Zabih Ghassemlooy is with Optical Communications Research Group, NCRLab, Faculty of Engineering and Environment, Northumbria University, NE1 8ST, Newcastle, U.K. (e-mail: z.ghassemlooy@northumbria.ac.uk).

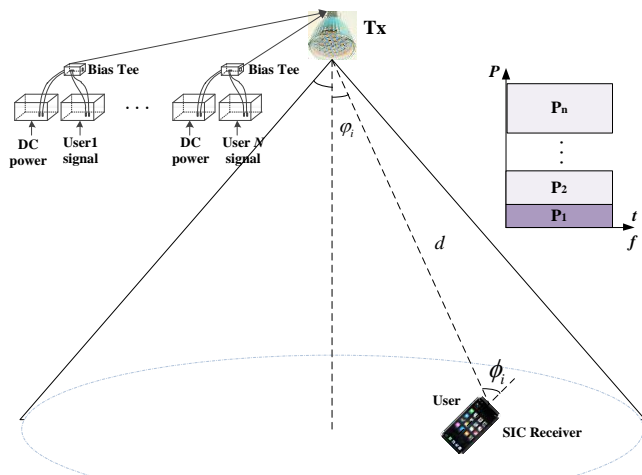

Fig. 1. Downlink OPD-NOMA-VLC with 2 users. (ϕ_i : the angle of irradiance, ϕ_i : the angle of incidence, and d : transmission distance)

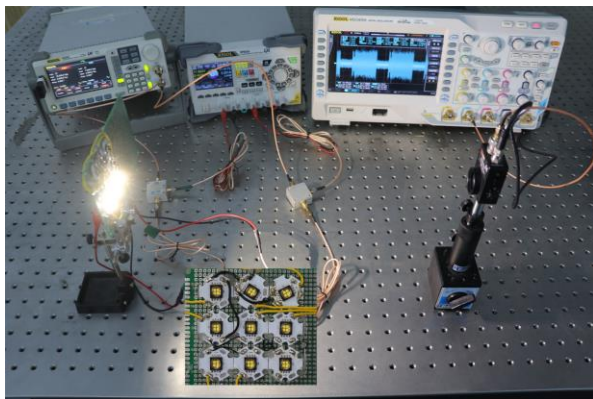

Fig. 2 Experiment setup for OPD-NOMA-VLC.

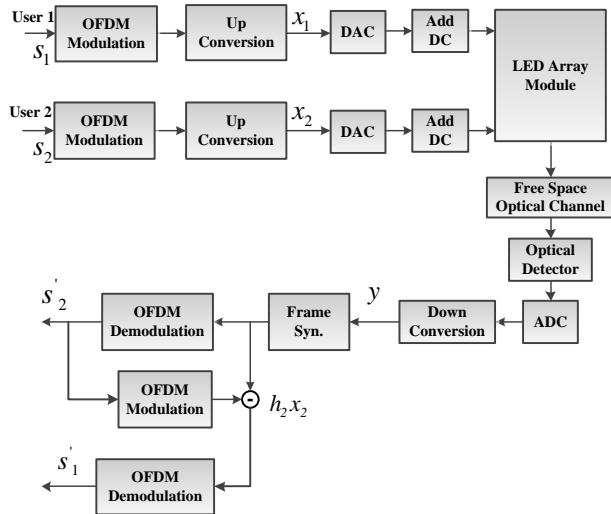

Fig.3 Block diagram for the downlink OPD-NOMA-VLC.

II. TECHNIQUE PRINCIPLE

Fig. 1 shows the block diagram for the OPD-NOMA-VLC with N users. At the Tx, LEDs in the LED array are divided into N groups and each group is driven by a user with a particular driver circuit, where N is the number of users. The required number of driver circuits is equal to N . PD

multiplexing is performed by assigning different numbers of LEDs to different users. The data for each user is combined with a direct current (DC) prior to intensity modulation (IM) of the grouped LEDs. The LED drive current is $I_{DC}+I_t$ where I_{DC} is the DC and I_t is the transmit signal current for user t . Here we have assumed that LEDs have the same power-current (P - I) characteristic. The transmit optical power for user t is given by:

$$P_t = n_t \eta (I_{DC} + I_t), \quad (1)$$

where η is the LED's P - I modulation conversion coefficient and n_t is the number of LEDs assigned to user t . Following photo detection, the electrical signal for user t is given by:

$$I'_t = n_t \eta (I_t + I_{DC}) h \xi, \quad (2)$$

where ξ is the photodetector responsivity. In (2), we have assumed that the channel gains (i.e., h) are the same for all LEDs. In a typical VLC system where $d > 1m$, the power allocation ratio (PAR) of user 1 to user t is $\sim (n_1/n_t)^2$. Here we have assumed that, higher power is allocated to the user with higher index. In practical applications and considering a fair power allocation strategy, user with further distance from the Tx is allocated with more power. For OPD-NOMA the maximum drive current for the LEDs is $I_{max} = n_N(I_{DC} + I_N)$.

In conventional PD-NOMA schemes [8], power allocation is realized in the electrical domain, where the electrical signals for all users with pre-allocated power are combined prior to IM of LEDs. Using the same number of LEDs (i.e., $n_{LED} = n_1 + n_2 + \dots + n_N$) the total drive current is given by:

$$I_{LED} = n_{LED} I_{DC} + n_1 I_1 + n_2 I_2 + \dots + n_N I_N. \quad (3)$$

As such, the drive current of conventional PD-NOMA is significantly larger than that of OPD-NOMA. It is known that, the gain-bandwidth product of a driver circuit is a constant, which will limit the modulation bandwidth B_{mod} . As a result, B_{mod} in conventional PD-NOMA is smaller because it needs a higher gain to generate the same NOMA signal. In addition, a larger modulating signal (i.e., higher drive current) requires a LED and an electrical amplifier with much wider and linear dynamic range to ensure no clipping and saturation (i.e., no distortion).

In the conventional PD-NOMA scheme, dynamic power allocation methods such as gain ratio power allocation which consider the users' channel conditions, offer improved performance compared with the static power allocation method [2]. However, when the number of LEDs used is small, realization of fair dynamic power allocation in OPD-NOMA is an issue since the values of available power allocation ratio are discrete. But the static power allocation method is still available for OPD-NOMA to make a fair power allocation.

III. EXPERIMENT SETUP AND RESULTS

Figure 2 shows the experimental setup for the proposed OPD-NOMA-VLC with two users. The detail block diagram is shown in Fig. 3. At the Tx, two 1.7 Mbaud baseband OFDM signals mapped to QPSK are up-converted to a radio frequency (RF) subcarrier with a frequency of 1.25 MHz. This is realized in the Matlab via the digital I-Q modulation scheme. The digital OFDM signals are converted to analog formats

TABLE I. SYSTEM PARAMETERS

Parameter	Value
LED	
• No. of LEDs	3, 4
• 3 dB Modulation bandwidth	2.5 MHz
• Semi-angle of half power	~ 60°
• DC bias for each LED	~ 85 mA
Optical Rx	
• Wavelength range	400-1000 nm
• Photodetector active area	1 mm ²
• Photodetector responsivity @ $\lambda=600$ nm	25 A/W
• Bandwidth	50 MHz
• Field of view	~90°
OFDM	
• DFT	256
• CP	8
• RF carrier	1.25 MHz
• Symbol rate	1.7 M
• Modulation format	QPSK
PAR _{1/2}	0.25, 0.11

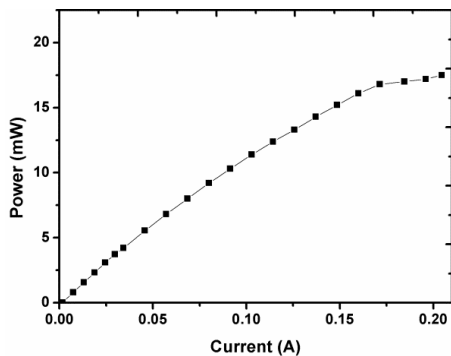

Fig. 4. Optical power versus the driven current for the LED.

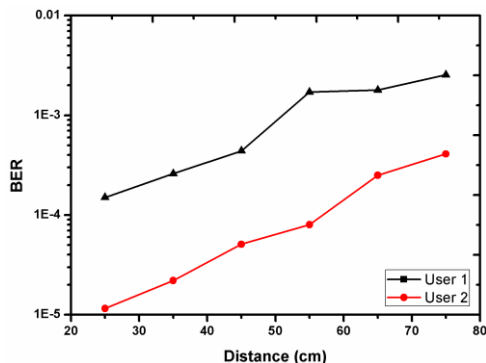

Fig. 5. BER performance for a PAR_{1/2} of 0.25 for users 1 and 2.

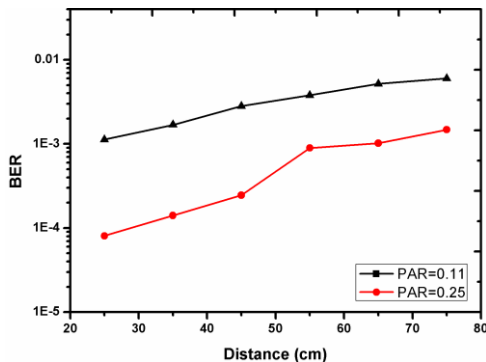

Fig. 6. Average BER performance as a function of the transmission distance for PAR_{1/2}S of 0.11 and 0.25.

using an arbitrary waveform generator (AWG, RIGOLDG5352). Note, the AWG also acts as a driver amplifier, and the maximum output peak to peak voltage (V_{pp}) is 20 V at the symbol rate of 1.7 M. The gain-bandwidth product is a constant for the driver amplifier. With the increase of the symbol rate, the maximum output is decreased. The LEDs in the LED array are divided into two groups and each group is assigned to a user. The electrical OFDM signals with different V_{pp} s are DC-level shifted using bias tee modules prior to IM of the grouped LEDs, respectively. The modulation bandwidth of the LED is 2.5 MHz. Fig. 4 depicts the $P-I$ characteristic of the LED with the linear region within the current range of 10 to 160 mA. In order to make a full use of the LED's dynamic range, the DC bias for each LED (i.e., I_{DC}) is set to 85 mA. At the receiver (Rx), a commercial optical Rx (APD 120A/M) is used to detect the optical signal. The detected signal is captured using a digital sampling oscilloscope (RIGOL MSO4054). Then the captured digital signal is decoded off-line in the Matlab domain using a SIC Rx. Note that the channel gain for each user should be estimated for SIC processing as shown in Fig. 3. All the key system parameters are provided in Table 1.

Fig. 5 depicts the BER performance as a function of the transmission distance for users 1 and 2. One and two LEDs are assigned to users 1 and 2, respectively. Each user has its own driven circuit. The power allocation ratio of user 1 to 2 (i.e. PAR_{1/2}) is 0.25. The DCs are 85 mA and 170 mA for user 1 and 2, respectively. It is known that the amplitude of the transmitted signal for IM of the LED should be a tradeoff between modulation index and LED nonlinearity. A higher modulation index offers a higher optical signal power thus provides a higher SNR, but suffers from higher nonlinear distortion. In the experiment, the V_{pp} of the driving signal is optimized to be 7.5 V for each LED. Therefore, the V_{pp} values for OFDM signals are set to 7.5 V and 15 V for users 1 and 2, respectively.

Fig. 6 illustrates the average BER performance as a function of the transmission distance for PAR_{1/2} values of 0.11 and 0.25. For a PAR_{1/2} of 0.11, one and three LEDs are assigned to users 1 and 2, respectively. The DCs for users 1 and 2 are 85 mA and 255 mA, respectively. For the OFDM signals V_{pp} are 6.6 V and 20 V for users 1 and 2, respectively. Since V_{pp-Max} of the driver circuit is 20 V, we have to reduce the amplitude of driving signal to each LED. As shown in Fig. 5, user 2 which is allocated with more power has better BER performance. Considering the user's fairness, user with further distance from the Tx is allocated with more power. In the dynamic power allocation method, the Tx should know all the users' channel conditions in order to ensure user's fairness but at the cost of increased complexity. In the static power allocation method, a simpler approach to ensure fair power allocation is to consider optimum average BER performance of the link. In our previous work [8], we showed that, the optimum PAR_{1/2} is 0.25 to achieve the best average BER performance.

We also consider a conventional PD-NOMA scheme with two users. At the Tx, two OFDM signals are generated and combined together with a pre-defined PAR in the Matlab domain. An AWG is used to generate the electrical version of

the combined signal for IM of all three LEDs following DC-level shifting, as shown in Fig. 7. The key parameters are similar to the OPD-NOMA scheme as shown in Table 1. At the Rx, the optical NOMA signal is detected by a photo detector and then decoded by a SIC Rx. The optimum V_{pp} of the driving signal should be 22.5 V in order to make full use of the linear modulation range of LEDs. However, V_{pp-Max} of the driver circuit is 20 V, therefore, V_{pp} of the NOMA signal is set to 20 V, which cannot make full use of the $P-I$ linear range of the LED. In OPD-NOMA, the optimum V_{pp} values for the transmitted signals are 7.5 V and 15 V for users 1 and 2, respectively. Therefore the maximum drive current is about 2/3 of that of PD-NOMA in order to achieve the optimum modulation index.

With the same DC bias and amplitude of driving signal for each LED in the LED array (i.e., $I_{DC} = 85$ mA, $V_{pp} = 6.6$ V), the BER performance for conventional PD-NOMA and proposed OPD-NOMA are comparable as shown in Fig. 8. However, the BER performance of OPD-NOMA can be improved further by increasing V_{pp} of the driving signal applied to each LED. As such, the obtainable BER performance of OPD-NOMA is better than PD-NOMA using the same driver circuit with a limited gain-bandwidth product. With the increase of the signal bandwidth, the V_{pp-Max} of the driver circuit is further reduced. With even lower values of V_{pp-Max} (i.e., 15 V), the performance gain of OPD-NOMA is expected to be more impressive in contrast to PD-NOMA. In practical applications, an array with a higher number of LEDs is required to ensure sufficient illumination in indoor environments. The implication of this is that PD-NOMA will require a higher LED drive current. Whereas, in OPD-NOMA LEDs in an array are divided into a number of groups with each group being driven by a user with a particular driver circuit. Therefore, the maximum drive current together with the requirement for gain-bandwidth product and cost are reduced compared to PD-NOMA. In addition, the transmitted signals with lower power levels suffer from reduced nonlinear distortion caused by the LED and amplifiers.

IV. CONCLUSION

We proposed an optical power domain based NOMA scheme for VLC. The maximum driven current for OPD-NOMA was significantly reduced compared to that for conventional PD-NOMA, which reduced the gain-bandwidth product requirement for the driver circuit. We showed by means of experimental investigation that OPD-NOMA offered improved BER performance compared to conventional NOMA using the same driver circuit but with a limited gain-bandwidth product.

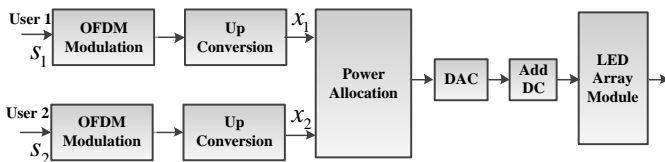

Fig. 7. The block diagram of the transmitter for PD-NOMA VLC.

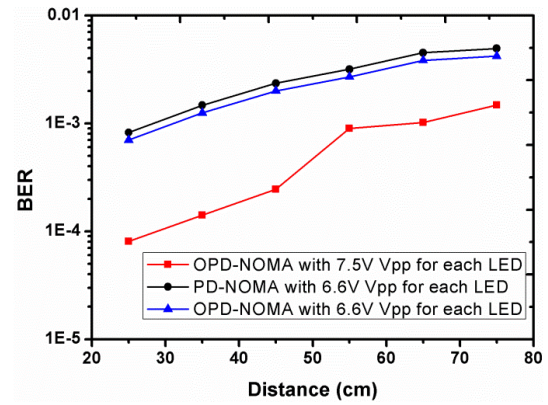

Fig. 8. Average BER performance for OPD-NOMA and PD-NOMA for a $PAR_{1/2}$ of 0.25.

REFERENCES

- Z. Ghassemlooy, W. Popoola, and S. Rajbhandari, *Optical Wireless Communications: System and Channel Modelling With MATLAB* (Taylor & Francis, 2012).
- H. Marshoud, V. M. Kapinas, G. K. Karagiannidis, S. Muhaidat, "Non-Orthogonal Multiple Access for Visible Light Communications," *IEEE Photon. Technol. Lett.*, **28** (1), 51-54 (2016).
- L. Yin, W. O. Popoola, X. Wu, and H. Haas, "Performance evaluation of non-orthogonal multiple access in visible light communication," *IEEE Trans. Commun.*, vol. 64, no. 12, pp. 5162–5175, Dec. 2016.
- R. C. Kizilirmak, C. R. Rowell, and M. Uysal, "Non-orthogonal multiple access (NOMA) for indoor visible light communications," *IEEE International Workshop on Optical Wireless Communications*, 2015, pp. 98–101.
- X. Zhang, Q. Gao, C. Gong, and Z. Xu, "User grouping and power allocation for NOMA visible light communication multi-cell networks," *IEEE Commun. Lett.*, **21** (4), 777–780 (2016).
- L. Yin, W. O. Popoola, X. Wu, and H. Haas, "Performance evaluation of non-orthogonal multiple access in visible light communication," *IEEE Trans. Commun.*, **64** (12), 5162–5175 (2016).
- X. Guan, Y. Hong, Q. Yang, and C. C.-K. Chan, "Non-orthogonal multiple access with phase pre-distortion in visible light communication," *Opt. Exp.*, **24** (22), 25816–25823 (2016).
- Bangjiang Lin, Weiping Ye, Xuan Tang, and Zabih Ghassemlooy, "Experimental demonstration of bidirectional NOMA-OFDMA visible light communications," *Opt. Exp.*, **25** (4), 4348–4355 (2016).
- B. Lin, Z. Ghassemlooy, X. Tang, Y. Li, and M. Zhang, "Experimental demonstration of optical MIMO NOMA-VLC with single carrier transmission," *Opt. Commun.*, **402**, 52–55 (2017).
- Chen Chen, Wen-De Zhong, Helin Yang, and Pengfei Du, "On the Performance of MIMO-NOMA-Based Visible Light Communication Systems," *IEEE Photon. Technol. Lett.*, **30** (4), 307-310 (2018).
- J. Li, Z. Huang, X. Liu, Y. Ji, "Hybrid time-frequency domain equalization for LED nonlinearity mitigation in OFDM-based VLC systems", *Opt. Exp.*, **23** (1), 611–619 (2015).
- G. Stepniak, J. Siuzdak, and P. Zwierno, "Compensation of a VLC Phosphorescent White LED Nonlinearity by Means of Volterra DFE", *IEEE Photon. Technol. Lett.* **25** (16), 1597-1600, (2013).
- R. Mitra and V. Bhatia, "Chebyshev polynomial-based adaptive predistorter for nonlinear LED compensation in VLC," *IEEE Photon. Technol. Lett.*, **28** (10), 1053–1056 (2016).
- R. Mitra and V. Bhatia, "Precoded Chebyshev-NLMS-Based Pre-Distorter for Nonlinear LED Compensation in NOMA-VLC," *IEEE Trans. Commun.*, **65** (11), 4845-4856 (2017).
- T. Fath, C. Heller, and H. Haas, "Optical wireless transmitter employing discrete power level stepping," *J. Lightwave Technol.* **31**(11), 1734–1743 (2013).
- J. Yew, S. D. Dissanayake, and J. Armstrong, "Performance of an experimental optical DAC used in a visible light communication system," in *IEEE GLOBECOM Workshops* (2014), pp. 1110–1115.
- A. Yang, Y. Wu, M. Kavehrad, and G. Ni, "Grouped modulation scheme for led array light module in a visible light communication system," *IEEE Wirel. Commun.* **22**(2), 24–28 (2015).