

Northumbria Research Link

Citation: Kanesan, Thavamaran, Ng, Wai Pang, Ghassemlooy, Zabih and Lu, Chao (2012) Theoretical and experimental design of an alternative system to 2 x 2 MIMO for LTE over 60 km directly modulated RoF link. In: GLOBECOM: Global Communications Conference. IEEE, Piscataway, NJ, pp. 2959-2964. ISBN 978-1467349413

Published by: IEEE

URL: <http://dx.doi.org/10.1109/GLOCOM.2012.6503567>
<<http://dx.doi.org/10.1109/GLOCOM.2012.6503567>>

This version was downloaded from Northumbria Research Link:
<http://nrl.northumbria.ac.uk/8264/>

Northumbria University has developed Northumbria Research Link (NRL) to enable users to access the University's research output. Copyright © and moral rights for items on NRL are retained by the individual author(s) and/or other copyright owners. Single copies of full items can be reproduced, displayed or performed, and given to third parties in any format or medium for personal research or study, educational, or not-for-profit purposes without prior permission or charge, provided the authors, title and full bibliographic details are given, as well as a hyperlink and/or URL to the original metadata page. The content must not be changed in any way. Full items must not be sold commercially in any format or medium without formal permission of the copyright holder. The full policy is available online: <http://nrl.northumbria.ac.uk/policies.html>

This document may differ from the final, published version of the research and has been made available online in accordance with publisher policies. To read and/or cite from the published version of the research, please visit the publisher's website (a subscription may be required.)

www.northumbria.ac.uk/nrl



Theoretical and Experimental Design of an Alternative System to 2×2 MIMO for LTE over 60 km Directly Modulated RoF Link

T. Kanesan¹, *Student Member, IEEE*, W. P. Ng¹, *Senior Member, IEEE*, Z. Ghassemlooy¹, *Senior Member, IEEE* and C. Lu², *Member, IEEE*

¹Optical Communications Research Group, NCRLab, School of CEIS, Northumbria University, Newcastle upon Tyne, U.K.

²Photonics Research Center, Department of Electronics and Information Engineering, The Hong Kong Polytechnic University, Hung Hom, Kowloon, Hong Kong.

Email: ¹{thavamaran.kanesan, wai-pang.ng, z.ghassemlooy}@northumbria.ac.uk, ²chao.lu@inet.polyu.edu.hk

Abstract—Relay nodes (RN) are used as an important structure to extend the coverage of the Third Generation Partnership Program’s Long Term Evolution (3GPP-LTE). The promising technology as the interface between eNodeB (eNB) and RN is radio-over-fibre (RoF), due to its longer span transmission capability. In this paper, we propose an alternative technique to 2×2 multiple-input and multiple-output (MIMO) in LTE structure for transmission over 60 km directly modulated RoF link by introducing frequency division multiplexing (FDM) for orthogonal FDM (OFDM). The system is demonstrated theoretically and experimentally. In the baseband, quadrature phase shift keying (QPSK), 16-quadrature amplitude modulation (QAM) and 64-QAM are considered as the single carrier modulations (SCM) according to the LTE standard. The system degradation pattern is identical between the theoretical and experimental system, thus proving the accuracy of the theoretical system design. The real time QPSK, 16-QAM and 64-QAM system achieved an average EVM of 5.84%, 5.90% and 5.97%, respectively for 2 GHz and 2.6 GHz bands. These resultant EVMs are below the 8% 3GPP-LTE EVM requirement.

Index Terms— Long Term Evolution (LTE); Radio-over-fibre (RoF); Relay node (RN); Multiple-input and multiple-output (MIMO)

I. INTRODUCTION

The 3GPP LTE also known as the 4th generation technology is the potential key to meet the exponentially increasing demand of the mobile end users from the perspective of higher data rates and efficient bandwidth usage [1].

Recent research on LTE used either 2 GHz or 2.6 GHz as the spectrum allocation for urban locations [1, 2]. As the urban locations has non-line-of-sight (NLOS) operating environment, the coverage area of eNB in urban locations is much smaller than any of the former technologies which has a radius of 1 km [2, 3]. The small cell radius will result in additional deployment of eNB units which would increase the cost and complexity, thus the total cost of ownership (TCO). Cost becomes a major factor from increasing the volume of eNB deployment due to eNB’s complex design with all the advances by signal processing and smart antenna techniques [4]. Fig. 1 depicts the overview of the LTE radio access network structure with a conceptual idea of urban area deployment.

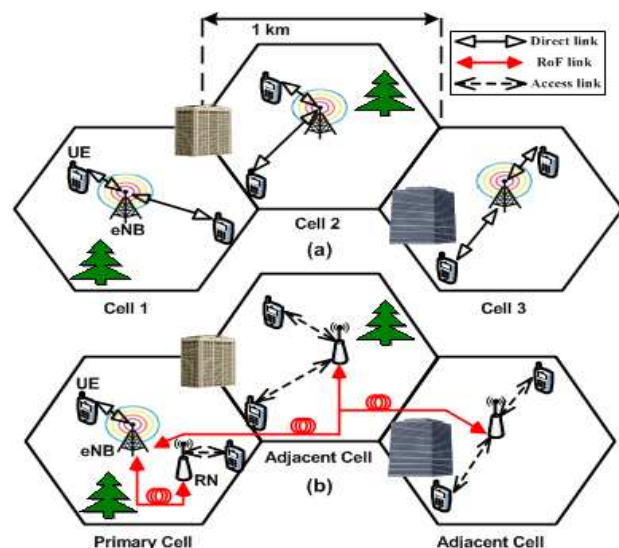

Fig. 1: LTE radio access network structure (a) without RN and (b) with RN in urban zone.

Fig. 1(a) shows the current proposed field deployment by 3GPP where eNB has to be deployed at every consecutive cell with 1 km radius labeled as cell 1, cell 2 and cell 3. The eNB is connected to the user equipment (UE) directly in this case. In Fig. 1(b), our proposed method is shown where within the primary cell, the eNB is connected to UE via RN employing RoF technology to provide a consistent signal-to-noise ratio (SNR). The eNB coverage is further extended to the adjacent cell with RoF interface. The major perspective of such strategy in the RN deployments is to decrease the number of eNBs which directly reduces the TCO. We have theoretically carried out the cell extension of LTE with RoF system [5, 6]. The analysis in [5] revealed that the system could achieve a maximum potential transmission distance of 119 km for QPSK-OFDM with directly modulated RoF system and showed the feasibility of coverage that RoF can provide for adjacent cell deployments with single antenna transmission. This paper focuses, for the first time, both theoretical and experimental system design of LTE-RoF for 2×2 MIMO. The 2×2 MIMO was achieved with introducing an alternative technique which utilizes FDM for OFDM.

The rest of the paper is organized as follows. Section II explains the problem of MIMO signal transmission over fibre

and the proposed system. Section III introduces the comprehensive theoretical model of the system and experimental implementation. Section IV presents and discusses the obtained results. Finally, Section V concludes the findings of the paper.

II. MIMO TRANSMISSION OVER FIBRE

The LTE physical layer consists of complex topologies including the MIMO and OFDM with various types of SCM [7]. Transmitting MIMO signals over optical fibre is not trivial because the group of signals in MIMO is configured at the same carrier frequency. The problem arises when this group of signals are combined and modulated on the same corresponding optical carrier. After the photodetection, it is impossible to recover individual electrical signal with filtering because the photodetection causes an intermixing effect in the electrical domain. In summary, the potential failures occurs in providing the necessary diversity to the MIMO signals from different antenna are due to modulation of these signals onto the same wavelength and the intermixing effect upon photodetection [8, 9].

A. Proposed System

The straightforward solution to this problem is to utilize individual lasers, optical fibers and photodetectors (PD) for each MIMO antenna by introducing wavelength division multiplexing with an individual wavelength carrier for each MIMO signals [8]. Jansen *et al* [10] has also introduced externally modulated optical polarization multiplexing system with coherent detection to solve the associated problem with MIMO modulation in optical system. All these systems will significantly increase the cost of implementation with respect to the number of MIMO antennas and system complexity.

As an alternative solution to this problem, we are proposing OFDM over analogue FDM (FDM-OFDM) for LTE in the context of 2x2 MIMO. Kobayashi *et al* [11] experimentally transmitted FDM-OFDM up to 80 km single mode fibre (SMF) with external modulation and coherent detection which also increases the cost and complexity of the optical system. On the other hand, Liu *et al* [8] experimentally demonstrated FDM based directly modulated RoF system for

Parameters	Values
SCM modulations	QPSK, 16-QAM, 64-QAM
Baseband multiplexing	OFDM
PAPR	QPSK=11.16 dB, 16-QAM=11.3 dB, and 64-QAM=11.67 dB
Passband multiplexing	FDM
Bit rate	QPSK=66 Mb/s, 16-QAM=134 Mb/s, and 64-QAM=200 Mb/s
Signal bandwidth	OFDM=20 MHz, FDM-OFDM=40 MHz
Carrier frequencies	2 GHz and 2.6 GHz
RF power	1 dBm
DFB bias	60 mA
Optical power	6.93 dBm
Linewidth	6.89 MHz
RIN	-149.6 dB/Hz
Wavelength	1551.11 nm
Optical launch power	-8 dBm – 0 dBm
SMF length	60 km
EDFA- gain, NF	6 dB, 3.5 dB
PD responsivity	0.42
LNA- gain, NF	18 dB, 2.5 dB

indoor application by utilizing 550 m multimode fibre.

The objective of this paper is to practically implement a directly modulated link with the intention of lowering the cost of LTE-RoF integration. In addition, we are transmitting the signal over 60 km SMF with simple direct detection (DD) based receiver. The transmission span is limited to 60 km due to the limited SMF availability in our laboratory. However, our theoretical studies has revealed that the system could achieve up to 119 km [5]. DD based system configuration is cost efficient due to the reduced amount of required components. The OFDM modulated data from each antenna are up-converted to 2 GHz and 2.6 GHz respectively by taking the advantage of the spectrum bands allocated for LTE [1, 12]. In RN, it is practically possible to transmit two frequencies with a single antenna that has multiband transmission capability to the respective UE's [13]. The implementation of the access network (see Fig. 1(b)) between RN and UE is

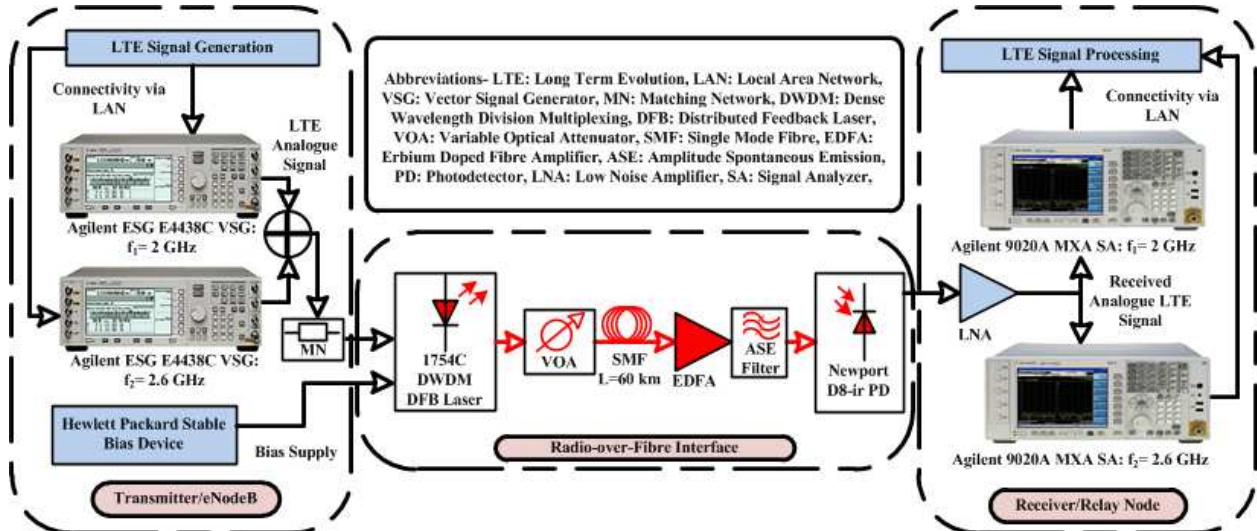

Fig. 2: Overall experimental setup of optical FDM

beyond the scope of this paper.

In terms of system design, we are investigating the physical layer connectivity according to the LTE standard using QPSK at 33 Mb/s, 16-QAM at 67 Mb/s, and 64-QAM at 100 Mb/s as the SCMs with OFDM [7]. Upon performing FDM-OFDM at 2 GHz and 2.6 GHz bands, the bit rate doubled for all modulation schemes. In the optical layer, a distributed feedback laser (DFB) is used as the direct modulation laser adopting intensity modulation (IM)-DD scheme to generate DD FDM-OFDM (DD-FDM). All the relevant system parameters are presented in table I.

The system is evaluated for both carrier frequencies after the photodetection. The evaluation is carried out in terms of all SCM's power penalty and error vector magnitude (EVM) at 60 km transmission for theoretical and experimental system.

III. SYSTEM MODEL

The experimental system shown in Fig. 2 is modeled in MATLABTM. Some of the important theoretical models are as follow:

A. OFDM Model

At the transmitter, the theoretical model of OFDM applied for the system modeling can be described as:

$$x(n) = \frac{1}{\sqrt{N}} \sum_{k=0}^{N-1} X(k) e^{j2\pi kn/N}, \quad n = 0, 1, \dots, N-1, \quad (1)$$

where N is the number of closely spaced subcarriers, $X(k)$ is the symbol level data modulated with the SCMs, k is the subcarrier frequency, n is the time domain sampling index and $x(n)$ is the OFDM modulated symbols. A fraction of each OFDM symbol known as the cyclic prefix is added to the front of each OFDM symbol. In the experimental work, this operation is known as LTE signal generation.

B. DFB model

DFB laser is the optical modulator utilized in this paper as part of the RoF interface. In theoretical modeling, direct modulation of a DFB laser with respect to an input signal is viable by adopting rate equations as given by (2) and (3). The rate equation is composed of the rate of change of carrier density dN/dt and the rate of change of photon density dS/dt [6]:

$$\frac{dN}{dt} = \frac{I_d}{eV} - \frac{N}{\tau_c} - G \frac{(N - N_t)}{1 + \varepsilon S} S \quad (2)$$

$$\frac{dS}{dt} = \frac{\Gamma G (N - N_t)}{1 + \varepsilon S} S - \frac{S}{\tau_p} + \frac{\Gamma \zeta N}{\tau_c} \quad (3)$$

where I_d is the total current injected into the DFB, e is the electronic charge, V is the volume, N is the carrier density, τ_c is the carrier decay rate, G is the linear optical gain coefficient, N_t is the transparency carrier density, ε is the nonlinear gain coefficient, S is the photon density, Γ is the mode confinement factor, τ_p is the photon decay rate and ζ is the fraction of spontaneous emission.

C. SMF

The transmission channel used for the system is SMF. Theoretically, the SMF model that governs the properties of dispersive and nonlinear propagation can be expressed by the

generalized nonlinear Schrödinger equation [14].

$$\frac{\partial A}{\partial z} - \frac{j}{2} \beta_2 \frac{\partial^2 A}{\partial T^2} + \frac{\alpha}{2} A = -j \frac{2\pi}{\lambda} n_2 |A|^2 A \quad (4)$$

where $A = A(z, T)$ is the slowly varying envelope of the traversing signal, z is the transmitting distance coefficient, β_2 is the second order dispersion coefficient, $T = t - z/v_g$ is the time in a step that propagates at the group velocity v_g , α is the SMF attenuation coefficient, λ is the optical wavelength, n_2 is the nonlinear index coefficient. Equation (4) was modelled using the symmetrical split-step method and known to have a good agreement with a practical optical fibre response [14].

D. Experimental link

The overall experimental setup for LTE-RoF system is shown in Fig. 2. All system parameters are presented in table I. The LTE signals generated for this experiment are QPSK, 16-QAM and 64-QAM with OFDM, respectively. The LTE signals have an analogue radio bandwidth of 20 MHz. At the complementary cumulative distribution function of 0.001%, the peak-to-average ratios (PAPRs) are ~ 11.16 dB, ~ 11.3 dB and ~ 11.67 dB for QPSK, 16-QAM and 64-QAM, respectively. The Vector Signal Generator (VSG) will then generate the real-time LTE signal based on the respective

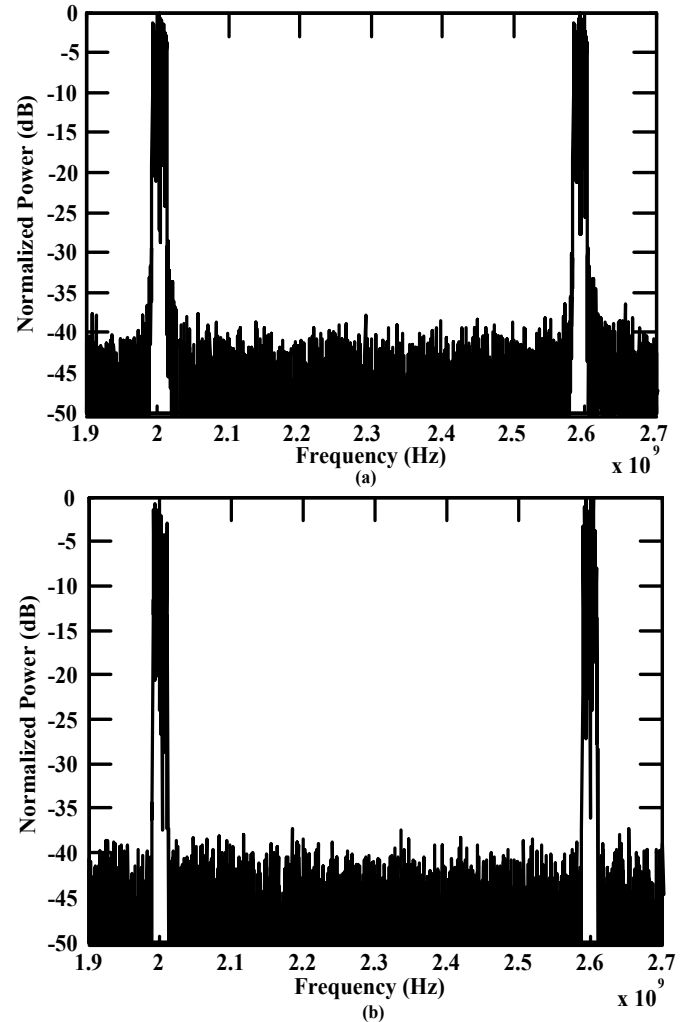

Fig. 3: Frequency spectrum of the FDM-OFDM signal of (a) theoretical and (b) experimental

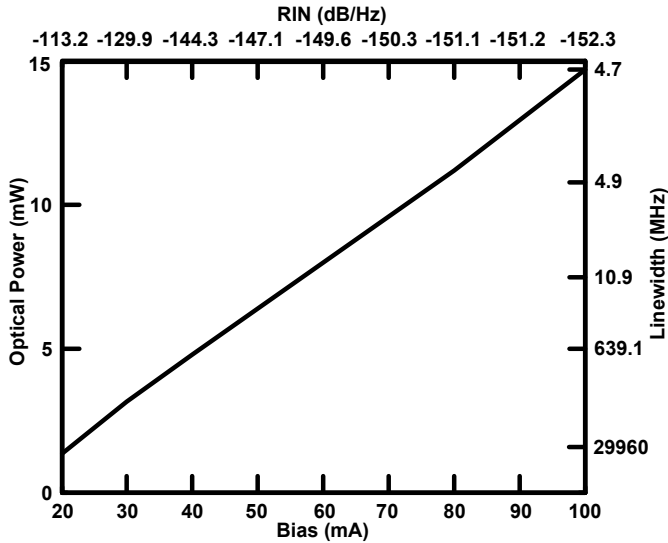

Fig. 4: Characterization of the DFB laser. The optical power, linewidth and RIN response varies linearly with respect to bias

modulation scheme and subsequently upconverted to $f_1 = 2$ GHz and $f_2 = 2.6$ GHz. The signals at the carrier frequencies of $f_1 = 2$ GHz and $f_2 = 2.6$ GHz are summed to form the FDM-OFDM signal. Fig. 3 shows the frequency spectrum of the FDM-OFDM for both theoretical and experimental results. The experimental results are consistent to the theoretical prediction.

In the RoF interface shown in Fig. 2, the FDM-OFDM LTE signal is coupled into the matching network (MN) circuitry to provide the wideband matching for DML-1754C dense wavelength division multiplexing (DWDM) DFB laser. The signal from the MN is directly applied to the DFB laser to perform IM. The characteristics of the DFB laser is shown in Fig. 4 where the laser is biased at 60 mA, which provides an optical launch power (OLP), linewidth and relative intensity noise of 6.93 dBm, 6.89 MHz and -149.6 dB/Hz, respectively. As depicted in Fig. 2, the DFB modulated FDM-OFDM LTE signal (DD-FDM) is then coupled into a variable optical attenuator (VOA) to maintain the OLP within the linear region of 0 dBm to -8 dBm [5, 6]. After the VOA, signal traverse through 60 km of SMF and post-amplified via erbium doped fibre amplifier (EDFA) with gain of 6 dB and noise figure (NF) of 3.5 dB and filtered with amplitude spontaneous emission (ASE) filter before DD. The DD used is a Newport D8-ir PD with a responsivity of 0.42.

At the RN, a LNA is used to compensate the attenuation of the SMF. In a real system, this signal will broadcast via an antenna to the UE. In this paper, the signal is split and then analyzed by individual Signal Analyzer (SA)-Agilent 9020A MXA to ascertain the signal quality. The next section will discuss the performance of the system which is measured by the SNR and EVM.

IV. RESULTS AND DISCUSSION

Figs. 5(a), (b), and (c) depict the OLP against real-time power penalty for QPSK, 16-QAM and 64-QAM DD-FDM. Both theoretical and experimental measurements are captured after 60 km of transmission span. The theoretical and experimental result of all three modulation schemes shows minimum power penalty at 0 dBm OLP. The power penalty between 2 GHz and 2.6 GHz is ~ 1 dB; the penalty is due to the higher magnitude response of the DFB laser at 2 GHz.

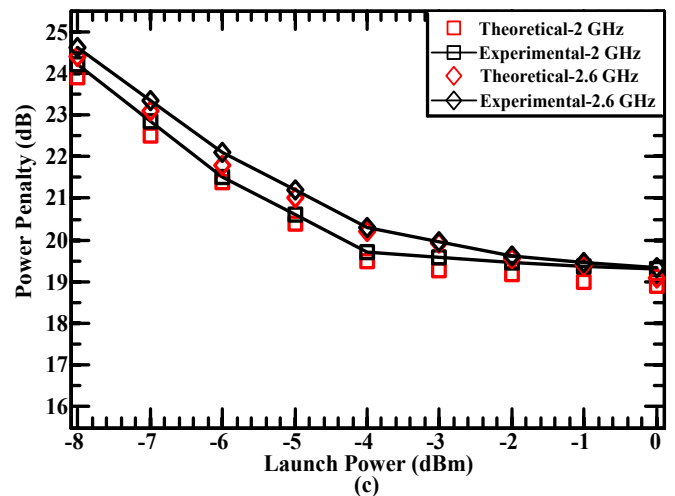
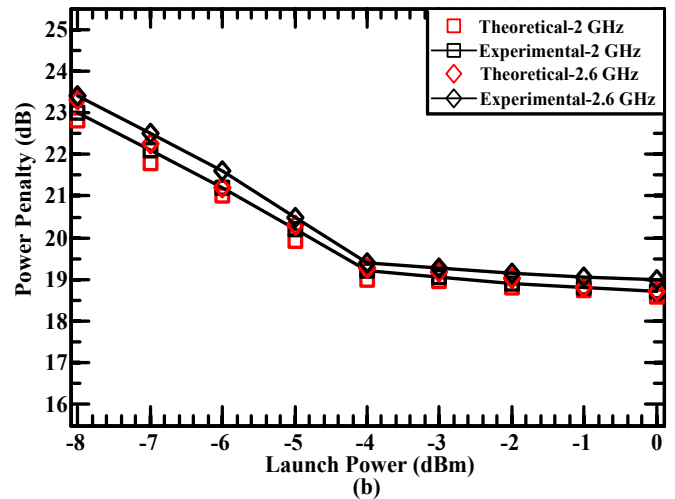
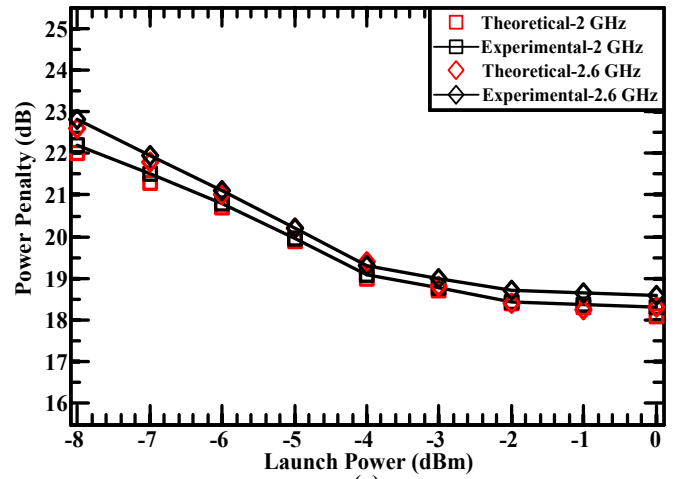

Fig. 5: OLP against power penalty analysis of (a) QPSK DD-FDM, (b) 16-QAM DD-FDM and (c) 64-QAM DD-FDM

At 0 dBm OLP (Fig. 5(a)), the power penalty of the theoretical QPSK system for 2 GHz and 2.6 GHz are ~ 18.1 dB and ~ 18.3 dB, respectively. Compared to the theoretical system, experimental result for 2 GHz and 2.6 GHz are ~ 18.3 dB and ~ 18.6 dB, respectively. Likewise, Figs. 5(b) and (c) experiences almost similar signal degradation pattern for both theoretical and experimental systems as the OLP reduces. The fundamental behind this degradation pattern is due to the decreasing SNR with respect to lower OLP.

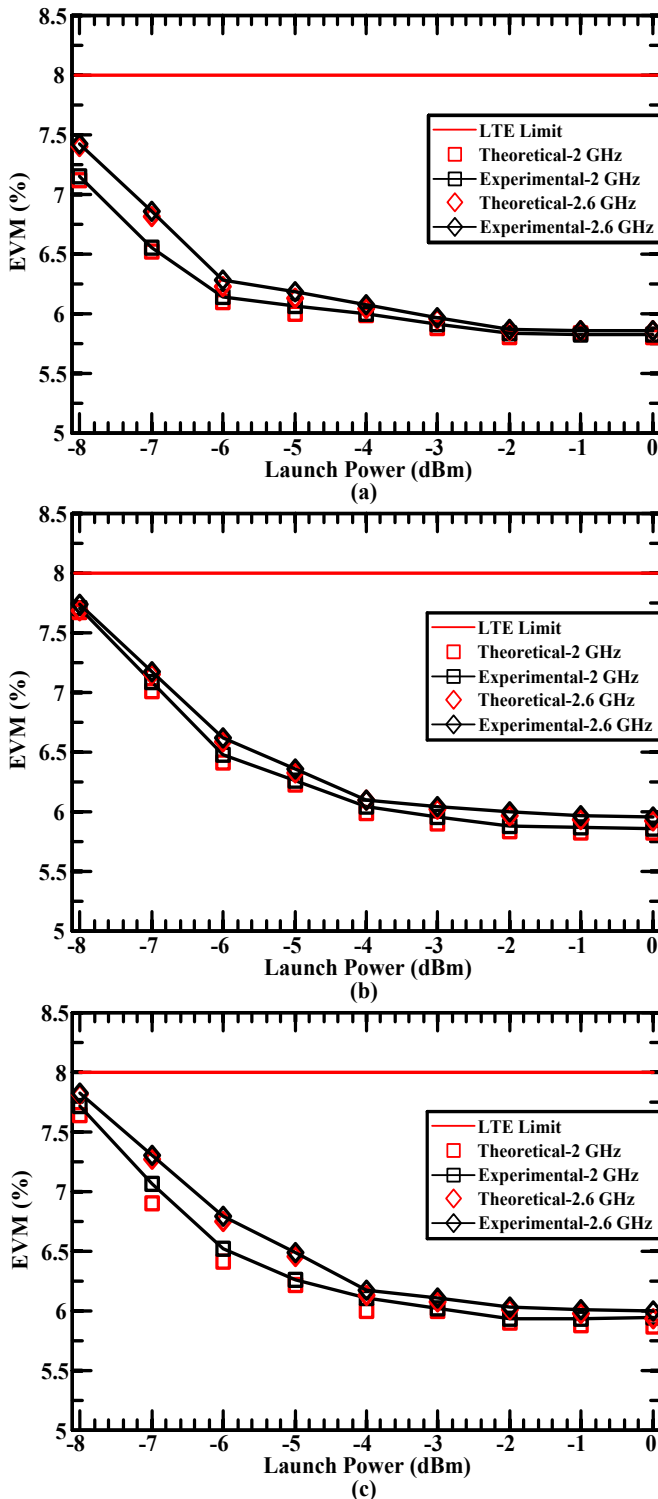

Fig. 6: OLP against EVManalysis of (a) QPSK DD-FDM, (b) 16-QAM DD-FDM and (c) 64-QAM DD-FDM

In addition to the power penalty analysis, EVM measurement is essential to define the exact system quality since the EVM requirement of 3GPP for LTE has to be less than 8% [15]. Figs. 6(a), (b), and (c) represent the EVM analysis of QPSK, 16-QAM and 64-QAM DD-FDM system. The results in Figs. 6(a), (b), and (c) provides the EVM for the theoretical and experimental system for 2 GHz and 2.6 GHz signals, respectively. It is clear that theoretical and experimental OLP of 0 dBm

TABLE II
THEORETICAL AND EXPERIMENTAL EVM DATA OF 0 dBm OLP

Modulation Scheme	2 GHz		2.6 GHz	
	Theory	Experiment	Theory	Experiment
QPSK	5.8%	5.82%	5.85%	5.86%
16-QAM	5.82%	5.85%	5.92%	5.95%
64-QAM	5.86%	5.94%	5.93%	5.99%

provides the lowest EVM for 2 GHz and 2.6 GHz across the aforementioned modulation schemes. The summary of the EVM data is shown in table II for 0 dBm OLP. At 0 dBm (Fig. 6(a) and table II), the EVM of the theoretical QPSK system for 2 GHz and 2.6 GHz are $\sim 5.8\%$ and $\sim 5.85\%$, respectively while the experimental QPSK system, achieves higher EVM at 2 GHz and 2.6 GHz of $\sim 5.82\%$ and $\sim 5.86\%$, respectively. The deviation between theoretical and experimental results is insignificant, while the curves of both theoretical and experimental system resulted in similar pattern, thus proving the accuracy of the theory.

In Fig. 6(a), EVM deteriorates as the OLP decreases. At OLP of -8 dBm, the EVM degrades to $\sim 7.11\%$ for 2 GHz and $\sim 7.4\%$ for 2.6 GHz theoretical QPSK system. The resultant EVM for experimental QPSK system operating at OLP of -8 dBm are $\sim 7.15\%$ and $\sim 7.42\%$ for 2 GHz and 2.6 GHz bands, respectively. Similar degradation pattern occurs for 16-QAM and 64-QAM system as shown in Figs. 5(b) and (c), respectively.

The qualitative measurement of the real-time system can be performed with respect to the 3GPP-LTE EVM limit of 8%. In the best case operating point at the OLP of 0 dBm, the 2 GHz and 2.6 GHz bands achieved low EVM (see table II) compared to the 8% EVM limit. For the worst case operating point at the OLP of -8 dBm, the average EVM for QPSK, 16-QAM and 64-QAM are $\sim 7.29\%$, $\sim 7.72\%$ and $\sim 7.77\%$, respectively for 2 GHz and 2.6 GHz bands. The worst case operating point is still within the limit of 3GPP-LTE requirement.

V. CONCLUSION

In this paper, we have proposed an alternative method for 2×2 MIMO systems in LTE-RoF by implementing DD-FDM both theoretically and experimentally. Taking into account the advantage of LTE spectrum allocation and our proposed solution, a two-fold gain in the peak data rate has been achieved in the 2×2 MIMO configuration. Our studies revealed that the resulting output quality of the signal is almost identical for both the 2 GHz and 2.6 GHz bands. At 200 Mb/s (64-QAM), the experimental system could achieve EVM of $\sim 5.935\%$ and $\sim 5.99\%$ for 2 GHz and 2.6 GHz system, respectively. In the proposed system, the EVM performance is within the 8% stipulated in the 3GPP LTE requirement. This system showed that directly modulated RoF link has a promising potential to extend the coverage of the eNB for adjacent cells and reduce the TCO significantly.

REFERENCES

- [1] "Mobile Communications Supplement: The LTE Supplement," in *informa telecoms & media*, 2010.
- [2] K. Dimou, W. Min, Y. Yu, M. Kazmi, A. Larmo, J. Pettersson, W. Muller, and Y. Timmer, "Handover within 3GPP LTE: Design Principles

- and Performance," in *Vehicular Technology Conference Fall (VTC 2009-Fall)*, 2009 IEEE 70th, pp. 1-5, 2009.
- [3] K. Hoon, C. Jae Hun, K. Sangho, S. Ki-Uk, L. Hanlim, L. Jaehoon, K. Byungjik, O. Yunje, L. Jaekon, and H. Seongtaek, "Radio-Over-Fiber System for TDD-Based OFDMA Wireless Communication Systems," *Lightwave Technology, Journal of*, vol. 25, pp. 3419-3427, 2007.
 - [4] S.W.Peters, A.Y.Panah, K.T.Truong, and J. R.W.Heath, "Relay Architectures for 3GPP LTE-Advanced," *EURASIP Journal on Wireless Communications and Networking*, vol. 2009, p. 14, 2009.
 - [5] T. Kanesan, W. P. Ng, Z. Ghassemlooy, and C. Lu, "FFT Size Optimization for LTE RoF in Nonlinear Fibre Propagation," in *Communication Systems Networks and Digital Signal Processing (CSNDSP)*, 8th International Symposium on, pp. -, 2012. (Accepted for Publication)
 - [6] T. Kanesan, W. P. Ng, Z. Ghassemlooy, and J. Perez, "Optimization of Optical Modulator for LTE RoF in Nonlinear Fiber Propagation," *IEEE Photonics Technology Letters*, vol. 24, pp. 617-619, 2012.
 - [7] Bruno Clerckx, Angel Lozano, Stefania Sesia, Cornelius van Rensburg, and C. B. Papadias, "3GPP LTE and LTE-Advanced," *EURASIP Journal on Wireless Communications and Networking*, vol. 2009, pp. 1-3, 2009.
 - [8] L. Chin-Pang and A. J. Seeds, "Transmission of Wireless MIMO-Type Signals Over a Single Optical Fiber Without WDM," *Microwave Theory and Techniques, IEEE Transactions on*, vol. 58, pp. 3094-3102, 2010.
 - [9] X. Zheng, X. Q. Jin, R. P. Giddings, J. L. Wei, E. Hugues-Salas, Y. H. Hong, and J. M. Tang, "Negative Power Penalties of Optical OFDM Signal Transmissions in Directly Modulated DFB Laser-Based IMDD Systems Incorporating Negative Dispersion Fibers," *Photonics Journal, IEEE*, vol. 2, pp. 532-542, 2010.
 - [10] S. L. Jansen, I. Morita, and H. Tanaka, "16x52.5-Gb/s, 50-GHz spaced, POLMUX-CO-OFDM transmission over 4,160 km of SSMF enabled by MIMO processing," *Optical Communication - Post-Deadline Papers (published 2008)*, 2007 33rd European Conference and Exhibition of, pp. 1-2, 2007.
 - [11] T. Kobayashi, A. Sano, E. Yamada, Y. Miyamoto, H. Takara, and A. Takada, "Electro-optically multiplexed 110 Gbit/s optical OFDM signal transmission over 80 km SMF without dispersion compensation," *Electronics Letters*, vol. 44, pp. 225-226, 2008.
 - [12] M. A. Ali, G. Ellinas, H. Erkan, A. Hadjiantonis, and R. Dorsinville, "On the Vision of Complete Fixed-Mobile Convergence," *Lightwave Technology, Journal of*, vol. 28, pp. 2343-2357, 2010.
 - [13] W. C. Liu and W. R. Chen, "CPW-fed compact meandered patch antenna for dual-band operation," *Electronics Letters*, vol. 40, pp. 1094-1095, 2004.
 - [14] F. Ramos, J. Marti, V. Polo, and J. M. Fuster, "On the use of fiber-induced self-phase modulation to reduce chromatic dispersion effects in microwave/millimeter-wave optical systems," *Photonics Technology Letters, IEEE*, vol. 10, pp. 1473-1475, 1998.
 - [15] 3GPP, "EVM for LTE Repeater (3GPP TSG-RAN4 Meeting #52, TS 36.143, Rel-8)," 2009.