

# Northumbria Research Link

Citation: Nimbark, Vishal, Lu, Qing, Korolkiewicz, Edward and Liu, Lei (2012) Design of a three port feed matching network for a dual-band and dual-polarized rectangular patch antenna. In: SPCOM 2012: International Conference on Signal Processing and Communications 2012, 22-25 July 2012, Bangalore, India.

URL: <http://www.ece.iisc.ernet.in/~spcom2012/> <<http://www.ece.iisc.ernet.in/~spcom2012/>>

This version was downloaded from Northumbria Research Link:  
<http://nrl.northumbria.ac.uk/8260/>

Northumbria University has developed Northumbria Research Link (NRL) to enable users to access the University's research output. Copyright © and moral rights for items on NRL are retained by the individual author(s) and/or other copyright owners. Single copies of full items can be reproduced, displayed or performed, and given to third parties in any format or medium for personal research or study, educational, or not-for-profit purposes without prior permission or charge, provided the authors, title and full bibliographic details are given, as well as a hyperlink and/or URL to the original metadata page. The content must not be changed in any way. Full items must not be sold commercially in any format or medium without formal permission of the copyright holder. The full policy is available online: <http://nrl.northumbria.ac.uk/policies.html>

This document may differ from the final, published version of the research and has been made available online in accordance with publisher policies. To read and/or cite from the published version of the research, please visit the publisher's website (a subscription may be required.)

[www.northumbria.ac.uk/nrl](http://www.northumbria.ac.uk/nrl)



# Design of a Three Port Feed Matching Network for a Dual- Band and Dual -Polarized Rectangular Patch Antenna

V. Nimbark

G.D. Goenka World Institute,  
Gurgaon Sohna Road  
Haryana,  
India

Vishal.nimbark@gdgoenka.ac.in

Q.Lu

School of Computing,  
Engineering and  
Information Sciences,  
Northumbria University,  
Newcastle upon Tyne, NE1  
8ST England  
qing.lu@northumbria.ac.uk

E. Korolkiewicz

School of Computing, Engineering  
and Information Sciences,  
Northumbria University, Newcastle  
upon Tyne, NE1 8ST England  
e.korolkiewicz@northumbria.ac.uk

L. Liu

School of Computing,  
Engineering and  
Information Sciences,  
Northumbria University,  
Newcastle upon Tyne,  
NE1 8ST England  
lei.liu@northumbria.ac.uk

**Abstract**—This paper presents practical design of a three port feed network for a dual- band and dual-polarized patch antenna operating at 1.9 GHz and 2.4 GHz. Initially, design graphs are used to determine the dimensions of the patch for dual band application and the component values of the two equivalent parallel tuned circuits of the antenna at each frequency. Finally the predicted and practical results are compared.

**Index Terms**— Transmission lines, Microstrip lines, patch antenna, three port network, dual frequency matching, microwave software,

## I. INTRODUCTION

There has been tremendous growth of mobile users; Wireless communication device such as mobile requires Bluetooth, GPS embedded into the mobile phones. There is an increasing demand for multi-band antennas that can be easily integrated with the rest of the system. These systems often require compact antennas. The microstrip antennas, which have features of light weight, low cost, and a conformal structure that can be integrated on the same board with the matching network and RF modules, becomes a popular choice [1]

Various design configurations such as probe feed, H shaped, rectangular microstrip antenna exist for dual frequency Microstrip patch antenna has been presented in the literature. [2, 3] presents probe fed dual frequency patch antennas. Single probe-fed rectangular microstrip patch antenna for dual and multi frequency operation has been presented in [2, 4]. A novel closed-form expression for edge extension in predicting of resonant frequency of rectangular microstrip antenna is presented in [3]. H-shaped microstrip antenna of two microstrip dipoles, which resonate at the antenna's two operating frequencies, has been investigated in [2] This paper presents complete design/matching solution for the dual frequency microstrip patch antenna operating at 1.9GHz

(used in PCS mobile applications) and 2.4GHz (used in Bluetooth application). The antenna must have a single feed so that it can be used for either of the above applications. The required return loss at each frequency is 15db [5-8]. Initially a design graph is used to determine the dimensions of the antenna. Then two other design graphs are used (for the input impedance and the 'Q' factor of the antenna) to obtain the component values of the two equivalent parallel tuned circuits at the two frequencies. Based on these results the three port feed network and the dual-band antenna is designed and modeled. Finally simulation and manufactured antenna results have been presented.

## II. DESIGN AND MODELING OF A RECTANGULAR PATCH ANTENNA

Dual frequency patch antenna and the feed network that is required to be designed is shown in Fig. 1. Dual frequency antenna is fabricated using inexpensive PCB FR4 substrate. For this substrate the dielectric constant is 4.3, the height is 1.575 mm, the loss tangent is 0.019 and the thickness of the copper is 0.035mm. This is an inexpensive substrate which has high substrate losses as compared with more expensive substrate where the loss tangent typically 0.001 that is normally used for this type of design.

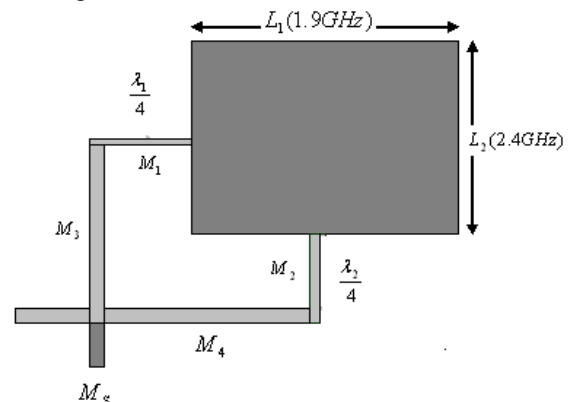

Fig.1 Antenna and the Feed Network

The theory of patch antennas and the transmission line model [9] are covered. For each design frequency the transmission model of the rectangular patch antenna is simplified to a parallel tuned circuit as shown in Fig.2. The dimensions of the patch and the component values of the parallel tuned circuits are obtained using the design graphs shown in Fig. 3 & 4.

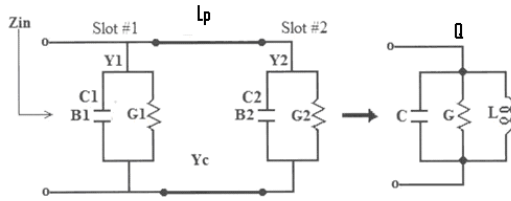

Fig.2 Transmission Line and Parallel Equivalent Circuits of the patch antenna

The dimensions of the patch and the component values of the equivalent parallel tuned circuits for each frequency are obtained using Figs. 3-5 produced using 'Advanced Design System' (ADS). These results have been derived through simulations.

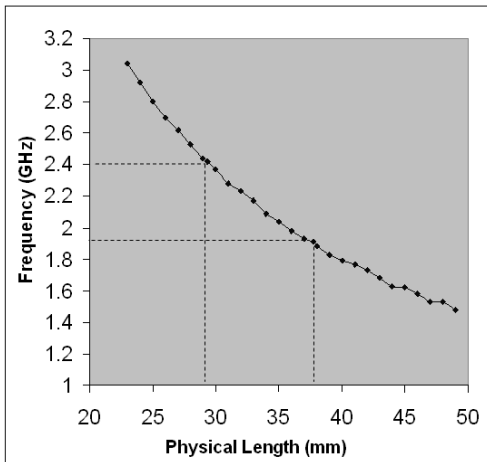

Fig.3 Physical length of the antenna in the frequency range 1-3 GHz

The two dimensions  $L1$  (at 1.9 GHz) and  $L2$  (at 2.4GHz) are obtained from Fig.3 while the corresponding Q factors and the edge impedance of the patch are obtained from Figs. 4 and 5. The edge impedances and the Q factors are then used to obtain the values of the reactive components for the two parallel tuned circuits.

### III. DESIGN THE FEED MATCHING NETWORK

The feed matching network and the equivalent circuits of the antenna at the two frequencies are shown in Fig. 6.

In the design of the feed network the following fundamental properties of parallel tuned circuits and transmission lines are used.

1) The impedance of a high Q parallel tuned circuit is high at resonance and as the frequency changes away from the resonant position the impedance reduces rapidly and consequently power can only radiate at the two specified frequencies.

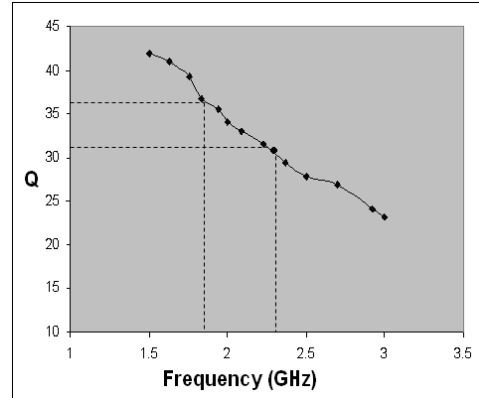

Fig.4 Q Factor of the antenna as a Function of Frequency

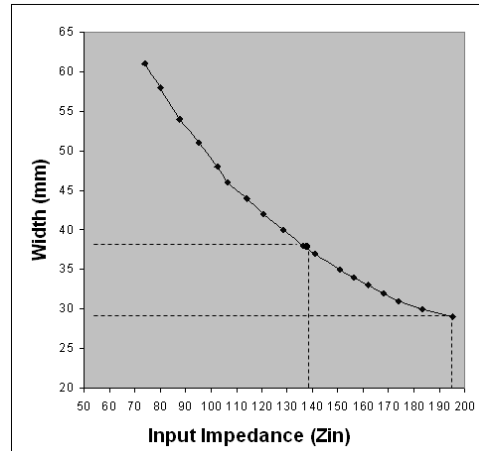

Fig.5 The edge input impedance at resonance as a function of the width of the patch.

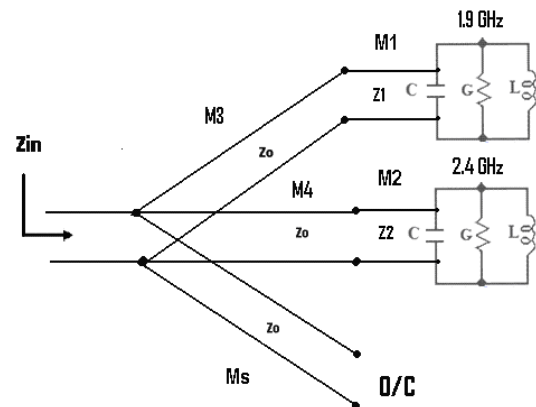

Fig.6 Equivalent Transmission Line Circuit of the Feed Network and Antenna

2) For a finite length of a transmission line terminated by a load impedance equal to the line's characteristic

impedance, the input impedance is constant and independent of the line's length.

3). It is possible to produce an open circuit at the junction of two lines of finite lengths connected in parallel, one terminated by an open circuit and the other by a short circuit.

The first step in the design of the feed network is to obtain the characteristic impedances of the two quarter wavelength transformers  $M_1$  and  $M_2$  to match the antenna two edge impedances to  $Z_0$  (50Ω).

At 1.9 GHz the line  $M_2$  in Fig. 7(a) is assumed to be effectively terminated by a short circuit and, together with the open circuit stub, produces an open circuit at the feed point so that all power is fed to the 1.9 GHz parallel tuned circuit. The input impedance  $Z_{IN1}$  looking into the line  $M_4$  in cascade with line  $M_2$  is given by equation (1) where all the variables are known except for  $\theta_4$  and consequently  $Z_{IN1}$  is only a function  $\theta_4$ .

$$Z_{IN1} = jZ_0 \left( \frac{Z_2 \tan \theta_2 + Z_0 \tan \theta_4}{Z_0 - Z_2 \tan \theta_2 \tan \theta_4} \right) \dots (1)$$

Similarly at 2.4 GHz the circuit shown in Fig. 7(b) produces an open circuit so that all power is fed to the antenna. Again it is assumed that  $M_1$  is terminated by a short circuit.

The input impedance  $Z_{IN2}$  of the line  $M_3$  connected in cascade with the line  $M_1$  is given by equation (2).

$$Z_{in2} = jZ_0 \left( \frac{Z_1 \tan \theta_1 + Z_0 \tan \theta_3}{Z_0 - Z_1 \tan \theta_1 \tan \theta_3} \right) \dots (2)$$

In equation (2) all the variables are known and  $Z_{IN2}$  is only a function of  $\theta_3$ . There is not a unique solution for equations (1) and (2) and the students are required to identify the constraints for  $\theta_4$  and  $\theta_3$ . These constraints include minimizing the coupling between the feed lines and to ensure that a single port feed can be used at the two frequencies. Based on these constraints it is necessary to assume a value for  $\theta_4$  or  $\theta_3$ .

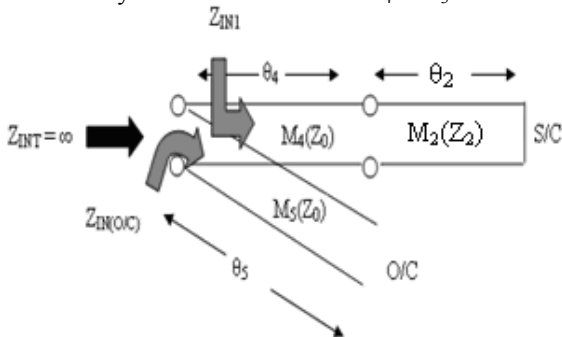

Figure.7 (a) Equivalent circuit to obtain matching at 1.9 GHz

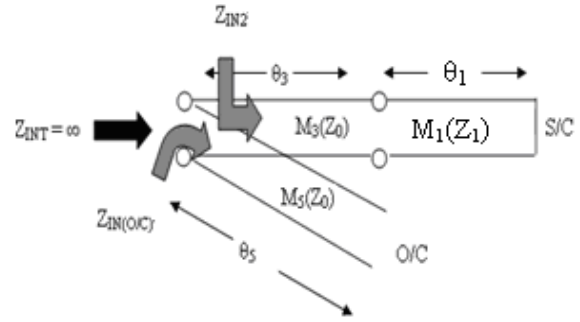

Figure.7 (b) Equivalent circuit to obtain matching at 2.4 GHz

#### IV. COMPARISON OF PREDICTED AND PRACTICAL RESULTS

The two dimensions, the edge impedances and the Q factors of the patch antenna at 1.9 GHz and 2.4 GHz obtained from Figures 3, 4 and 5 are shown in Table 1 below.

Table.1 Parameters of the dual-frequency patch antenna

	Physical length(Lp) (mm)	Q Factor	Input Impedances (Zin)(Ohms)
L1(at 1.9 GHz)	38	37	195
L2(at 2.4 Ghz)	29	31	138

The equivalent parallel tuned circuits at the two modes are obtained and modeled using MWO software. The impedance of the 1.9 GHz tuned circuit is  $0.635-j11 \Omega$  at 2.4 GHz while the impedance of the 2.4GHz tuned circuit is  $0.64+j9.4 \Omega$  at 1.9GHz. To satisfy the required length constraints of the feed network, for the 1.9 GHz feed and using assuming  $\theta = 174^\circ$  and  $Z_{IN1} = j157\Omega$  using equation (1).

It can be shown using the Smith chart that if the actual impedance of the 2.4GHz tuned circuit at 1.9GHz is used ( $0.64+j9.4 \Omega$  then  $\theta_4=170^\circ$  obtain the same input) impedance, Hence, the short circuit assumption of the tuned circuit is a good approximation. To produce the required open circuit at the feed position, the electrical length of M5 is  $18^\circ$  at 1.9 GHz.

At 2.4 GHz the input impedance of the open circuit line M 5 is  $-j120 \Omega$  and using equation (2) the electrical length  $\theta_3=145^\circ$  obtained. If the actual impedance ( $0.635-j11\Omega$ ) of the 1.9 GHz tuned circuit at 2.4GHz is used then  $\theta_3=149^\circ$  The results of the above designs are summarized in Table.2 assuming short circuits are used and in brackets the electrical lengths are for actual impedance values of the tuned circuits.

Table 2. Parameters of the lossless transmission line feed network for the short circuit conditions and brackets for the actual impedances

	M1	M2	M3	M4	M5
<b>Working Freq.(Ghz)</b>	1.9	2.4	2.4	1.9	1.9
<b>Electric length(B) (Degree)</b>	90	90	145 (149)	174 (170)	18
<b>Chara. impedances(ohm)</b>	98	83	50	50	50

Table.3 Dimensions of the microstrip lines used in the feed network

	M1	M3	M3	M4	M5
<b>L(mm)</b>	23	17.95	27.78	42	4.3
<b>W(mm)</b>	0.74	1.1	3	3	3

Table.3 summarizes the dimensions of the microstrip lines using FR4 substrate to realize the feed network shown in Fig. 6. Modeling the designs using MWO software, Fig.8 compares the frequency response for the return loss of the designed antenna using ideal and Microstrip lines.

MWO software also has the facility to optimize circuit designs. This was used to optimize the design where microstrip junctions and bends were included. The optimized dimensions of the feed network are given in Table. 4.

Table.4 Optimized dimensions of the feed network

	M1	M3	M3	M4	M5
<b>L(mm)</b>	23	17.73	32.75	41.8	4.19
<b>W(mm)</b>	0.74	1.3	3	3	3

The photograph of the antenna fabricated on PCB FR4 substrate is shown in Fig.9.

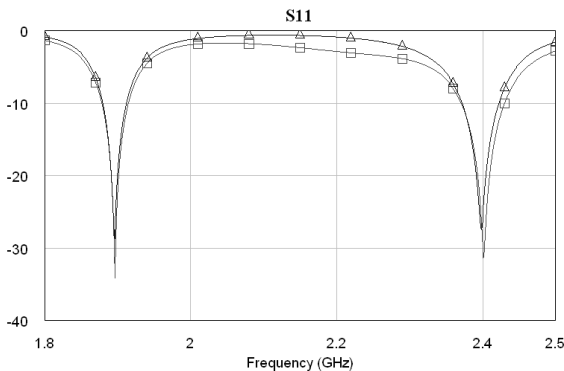

Figure.8 Return loss response of the designed antenna for ideal and Microstrip lines

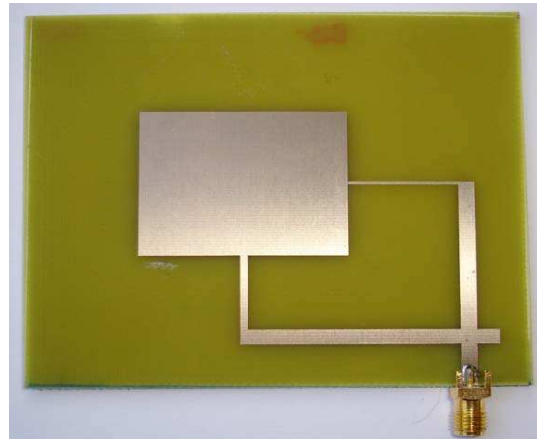

Fig.9 Photograph of the Fabricated Patch Antenna

The frequency response of the return loss obtained from practical measurements, predicted results using MWO and ADS software is compared in Fig.10.

There is an excellent agreement between the predicted results using MWO and ADS and a difference of 50MHz or approximately 2% for the practical results. As the relative permittivity of the PCB substrate at high frequencies is not accurately known and if the effect manufacturing errors are considered, then the accuracy of the obtained practical results is very good.

Fig.11 shows the polar patterns of the antenna at 1.9GHz and 2.4GHz obtained using ADS software where there is an excellent isolation between the two radiated modes. The frequency response of the gain of the antenna shown in Fig.12 was also obtained using ADS software. The gain is zero dB at 1.9 GHz and 2dB at 2.4GHz. The reason for these low gains is due to the high loss tangent of the substrate. If the loss tangent is changed to 0.001, which a typical value for substrates used in microwave designs, then the predicted gains from the ADs software are 3.4 dB (at 1.9GHz) and 3.97 dB (at 2.4 GHz).

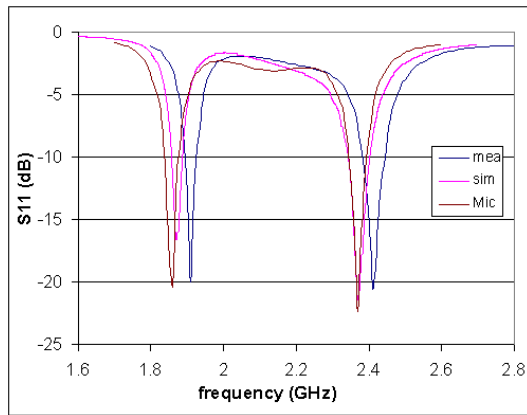

Fig.10 Practical and Simulated Results for the Return Loss

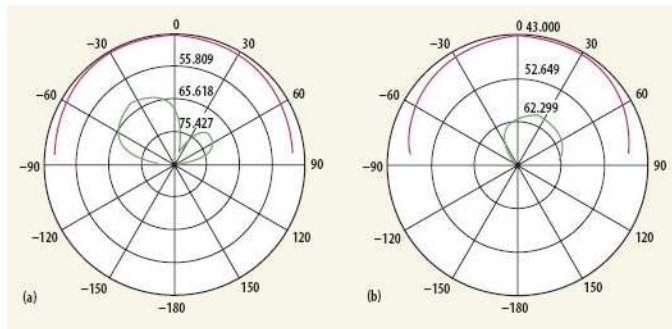

Fig.11 Polar Pattern at 1.9 and 2.4 GHz  
(a) at 1.9 GHz and (b) at 2.4 GHz

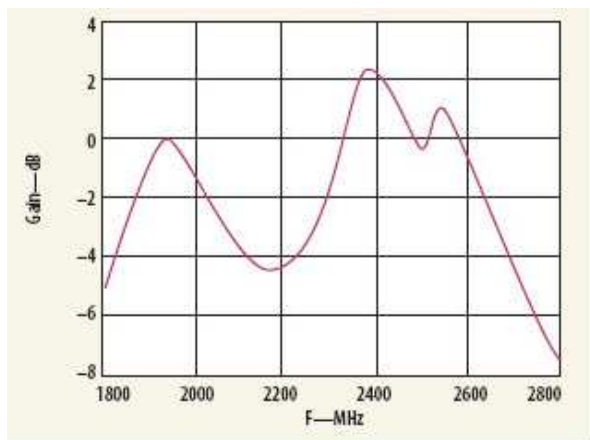

Fig.12 Frequency Response of the Gain of the Designed Antenna

### V. CONCLUSION

Design graphs are used to determine the dimensions of a dual frequency rectangular patch antenna and the circuit components of equivalent parallel tuned circuits for each mode. Then the properties of matched and reactively terminated ideal transmission lines are used to design the required feed network. As there is not a unique solution to the design equations they have to consider other constraints in order to obtain a practical feed network.

The ideal transmission lines are then replaced by Microstrip lines so that their designs can be fabricated and tested .Their designs for both the ideal and Microstrip lines are modeled using AWR Microwave Office software.

### VI REFERENCES

- [1] D.M. Pozar and D.H. Schaubert, Microstrip antenna design, IEEE Press, Piscataway, NJ, 1995.
- [2] Z. Huang, I X. Zhou, I J. Niu and J. Chen, "Novel design of a dual frequency and a multiport frequency microstrip antenna" pp.1129, Vol. 49, No. 5, May 2007, Microwave and Optical Technology Letters
- [3] A. Akdagli, " A closed form expression for the resonant frequency of rectangular Microstrip Antennas" pp. 1848-1851, Vol. 49, No. 8, August 2007, Microwave and Optical Technology Letters
- [4] S. Bhunia, D. Sarkar, S. Biswas, P.P. Sarkar and B. Gupta and K. Yasumoto " Reduced Size small Dual and Multi frequency Microstrip Antennas" pp 961-964 Vol. 50, No. 4, April 2008 , Microwave and Optical Technology Letters
- [5] D.M. Polar, Microwave Engineering, 3<sup>rd</sup> .end, John Wiley, 2005.
- [6] S.F. Ooi, S. K. Lee, A.Sambell, E.Korolkiewicz, and P. Butterworth, "Design of a High Efficiency Power Amplifier with Input and Output Harmonic Terminations" Vol.29,Issue2, pp. 391-395, Microwave and Optical Technology Letters, Dec. 2006.
- [7] C.Y. D. Sim, J.S. Row, and S.H. Chen "A Dual Band Antenna Design for GPS and UMTS Applications" pp 1935-1939, Vol. 49, No.8, Microwave and Optical Technology Letters. Aug. 2007
- [8] T. Berceci and T. Marozsak, "A New Microwave Amplifier Nonlinearity Measurement Method, Proc. of the 36<sup>th</sup> European Microwave Conference. Sept. 2006, Manchester UK
- [9] C. A. Balanis, "Antenna Theory: Analysis and Design," 2<sup>nd</sup> ed., Chap. 14, John Wiley & Sons, inc., New York, 1997.