

Northumbria Research Link

Citation: Delrot, Sabrina, Busawon, Krishna, Djemaï, Mohamed, Delmotte, François and Dambrine, Michel (2011) Fouling Detection in Heat Exchangers. In: Fouling Detection in Heat Exchangers World Congress, 28 August - 2 September 2011, Università Cattolica del Sacro Cuore, Milan.

URL: <http://dx.doi.org/10.3182/20110828-6-IT-1002.00581>
<<http://dx.doi.org/10.3182/20110828-6-IT-1002.00581>>

This version was downloaded from Northumbria Research Link:
<http://nrl.northumbria.ac.uk/5547/>

Northumbria University has developed Northumbria Research Link (NRL) to enable users to access the University's research output. Copyright © and moral rights for items on NRL are retained by the individual author(s) and/or other copyright owners. Single copies of full items can be reproduced, displayed or performed, and given to third parties in any format or medium for personal research or study, educational, or not-for-profit purposes without prior permission or charge, provided the authors, title and full bibliographic details are given, as well as a hyperlink and/or URL to the original metadata page. The content must not be changed in any way. Full items must not be sold commercially in any format or medium without formal permission of the copyright holder. The full policy is available online: <http://nrl.northumbria.ac.uk/policies.html>

This document may differ from the final, published version of the research and has been made available online in accordance with publisher policies. To read and/or cite from the published version of the research, please visit the publisher's website (a subscription may be required.)

www.northumbria.ac.uk/nrl



Fouling detection in heat exchangers

S. Delrot¹, K. Busawon³, M. Djemai¹, F. Delmotte^{1,2} and M. Dambrine¹

¹Univ Lille Nord de France, F-59000 Lille, France
UVHC, LAMIH, F-59313 Valenciennes, France
CNRS, UMR 8530, F-59313 Valenciennes, France

²LG2IA, Faculté des Sciences Appliquées, TechnoParc Futura, 62400 Béthune, France
sabrina.delrot@univ-valenciennes.fr, mohamed.djemai@univ-valenciennes.fr, francois.delmotte@univ-artois.fr

³Northumbria University, School of Computing, Engineering and Information Sciences
Newcastle Upon Tyne, NE1 8ST, UK
krishna.busawon@northumbria.ac.uk

Abstract: This paper deals with the design of a nonlinear observer for the purpose of detecting the fouling phenomenon that commonly occurs in heat exchangers. First, the general model of the heat exchanger is presented in terms of partial differential equations. Next, a simplified lump model is derived that is suitable for the observer design. The observer gains are generated by using appropriate Lyapunov functions, equations and inequalities.

Keywords: Heat exchanger, fouling, nonlinear observer, detection.

1. INTRODUCTION

The purpose of a heat exchanger is to transfer heat from one fluid to another. The heat transfer takes place between a hot and a cold fluid without contact between the two fluids, which flow along by a divided inner surface. We consider a tubular heat exchanger with two fluids with counter flow as illustrated in Figure 1.

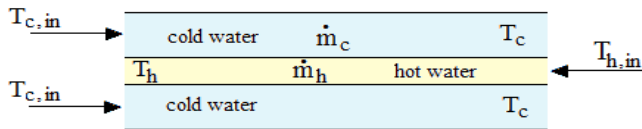

Fig. 1. Schematic of a tubular heat exchanger.

The following are employed throughout the paper :

Notations:

$T_{h,in}$: Inlet temperature on the hot side
 $T_{c,in}$: Inlet temperature on the cold side
 \dot{m}_h \dot{m}_c : Mass flow of hot (cold) fluid
 T_h T_c : Temperature in hot (cold) section

Additionally, h and c are used to represent hot and cold fluids respectively. These cold and hot fluids are opposite direction to have regular heat exchange. The heat transfer in heat exchangers is conducive to variations of fouling in fluids, which can cause corrosion, increase energy loss in the latter [Wolverine Tube Inc. (2001)].

In practice, it is important to measure the fouling by some means or other for diagnostic, monitoring and maintenance purpose (see e.g.[Hammouri et al. (2001)][Hammouri et al. (2002)][Kabore et al. (2001)][Kinnaert et al. (1999)]...).

However, fouling is measured by sensors that are generally expensive. Consequently, a more suitable solution would be to employ an observer in order to estimate the degree of fouling. However, the design of an observer for the heat exchanger is not an easy matter due to the highly nonlinear nature of the exchanger model. Furthermore, a precise model of the heat exchanger is described in terms of partial differential equations (PDE), and the design for nonlinear observers for systems described by PDEs is still an open problem. Consequently, one solution would be to derive an approximate model of the heat exchanger in terms of ordinary differential equations. As a matter of fact, some ODE-based observers such as the extended Kalman filter [Jonsson et al. (2007)], the neural Networks [Lalot et al.(2007)] and the use of fuzzy model [Delmotte et al. (2008)] have been used for that purpose.

In this paper, we propose a new observer for estimating the fouling in a heat exchanger based on a simplified model of the latter [Delrot et al. (2010)]. Unlike existing observers that are used for that purpose, the propose observer employs an appropriate Lyapunov equation, inequalities and function in order to update its gain. As a result, it imparts an adaptive characteristic to the propose observer. Simulation results are provided in order to show the performance of the observer using real measured data from a laboratory heat exchanger. Some comparative work is also carried out, in simulation, with respect to the estimation method used in [Delmotte et al. (2008)] to show the performance of the proposed observer for fouling detection. Finally some conclusions are presented.

2. THE MODEL OF THE HEAT EXCHANGER

The model of the heat exchanger presented hereafter the paper is borrowed from [6]. It is represented by the following partial differential equations:

$$\rho \bar{A}_h c_h \frac{dT_h(t, x)}{dt} + \rho \bar{A}_h c_h v_h \frac{\partial T_h(t, x)}{\partial x} = A_h U (T_c(t, x) - T_h(t, x)) \quad (1)$$

$$\rho \bar{A}_c c_c \frac{dT_c(t, x)}{dt} + \rho \bar{A}_c c_c v_c \frac{\partial T_c(t, x)}{\partial x} = A_c U (T_h(t, x) - T_c(t, x))$$

$$\text{and } T_c(t, 0) = T_{c,in} ; \quad T_h(t, 0) = T_{h,in}$$

where:

A_h : Area of the convection surface,

\bar{A}_h and \bar{A}_c : Areas of sections swept by the flow,

U : Overall heat transfer coefficient,

v : Speed of the flow, ρ : Density, and c : Specific heat capacity.

A finite state model can be obtained by deriving a lump model of the process [Jonsson (1990)]. If we consider only one section the equation (1) yields:

$$\begin{cases} M_h c_h \frac{dT_{h,i}}{dt} = \dot{m}_h (T_{c,i} - T_{h,i}) - A_h U (T_{h,i} - T_{c,i}) \\ M_c c_c \frac{dT_{c,i}}{dt} = \dot{m}_c (T_{c,i} - T_{c,i}) + A_c U (T_{h,i} - T_{c,i}) \end{cases} \quad (2)$$

with: $\Delta T_i = [T_{h,i} + T_{h,i-1}] / 2 - [T_{c,i} + T_{c,i-1}] / 2$;

$$M_h = \rho \bar{A}_h ; M_c = \rho \bar{A}_c ;$$

$$\dot{m}_h = \rho \bar{A}_h v_h \quad \text{et} \quad \dot{m}_c = \rho \bar{A}_c v_c \quad \text{and}$$

$$\frac{\partial T_{h,i}}{\partial x} = \frac{T_{h,i} - T_{h,i-\Delta x}}{\Delta x} = T_{h,i} - T_{h,i-1} ;$$

and M represent the mass for the hot and cold fluid.

Then, we replace equation (2) by this state space form:

$$\begin{pmatrix} \dot{T}_{h,i} \\ \dot{T}_{c,i} \end{pmatrix} = \begin{pmatrix} -\left(1 + \frac{\alpha}{2}\right) / \tau_h & \frac{\alpha}{2\tau_h} \\ \frac{\beta}{2\tau_c} & -\left(1 + \frac{\beta}{2}\right) / \tau_c \end{pmatrix} \begin{pmatrix} T_{h,i} \\ T_{c,i} \end{pmatrix} + \begin{pmatrix} \left(1 - \frac{\alpha}{2}\right) / \tau_h & \frac{\alpha}{2\tau_h} \\ \frac{\beta}{2\tau_c} & \left(1 - \frac{\beta}{2}\right) / \tau_c \end{pmatrix} \begin{pmatrix} T_{h,in} \\ T_{c,in} \end{pmatrix} \quad (3)$$

with

$$\alpha = \frac{A_h U}{\dot{m}_h c_h} ; \tau_h = \frac{M_h}{\dot{m}_h} ; \beta = \frac{A_c U}{\dot{m}_c c_c} ;$$

$$\tau_c = \frac{M_c}{\dot{m}_c} ; \text{ and } \alpha, \beta, \tau_h, \tau_c \text{ are the model parameters.}$$

Generally, (3) can be written as :

$$\frac{d}{dt} T = A \dot{m} T + B \dot{m} T_{in} \quad (4)$$

With T and \dot{m} are state vectors.

To have many sections instead of one, the outputs of the previous section will become the inputs of the next section. The number of sections in the model may of course be increased but in [Jonsson (1990)], it is shown that it is sufficient to cut the process in two sections (even if we can extend the number of section) in order to obtain a reliable lump model. We obviously assume homogeneity inside each four areas defined as can be seen in Figure 2.

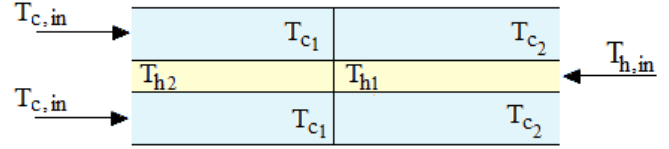

Fig. 2 : Heat exchanger with two sections.

With these assumptions, the model obtained will be in the form of differential equations.

The input variables are the temperatures and flows of cold and hot fluids (here is water) : $u = [T_{h,in} \ T_{c,in} \ \dot{m}_h \ \dot{m}_c]^T$

The complete state vector of system is given by:

$$x = [T_{h,1} \ T_{h,2} \ T_{c,1} \ T_{c,2}]^T$$

And the parameters vector to estimate is given by : $z = [\alpha \ \beta]^T$, where α and β are the parameters that depend on estimating fouling state. We assume that these two parameters vary slowly in the time and so their derivatives are almost zero.

As a result, the physical model of system with two sections represented by the following form:

$$\frac{dx}{dt} = A z, u x + B z, u \quad (5)$$

$$A z, u = \begin{bmatrix} -c_h - c_\alpha & 0 & c_\alpha & c_\alpha \\ c_h - c_\alpha & -c_h - c_\alpha & c_\alpha & 0 \\ c_\beta & c_\beta & -c_c - c_\beta & 0 \\ c_\beta & 0 & c_c - c_\beta & -c_c - c_\beta \end{bmatrix}$$

$$B z, u = \begin{bmatrix} c_h - c_\alpha & 0 \\ 0 & c_\alpha \\ 0 & c_c - c_\beta \\ c_\beta & 0 \end{bmatrix}$$

$$\text{And } c_h = \frac{\dot{m}_h}{\tau_h^* \dot{m}_h^*}, c_\alpha = \frac{\alpha}{2\tau_h^*} \gamma_U, c_c = \frac{\dot{m}_c}{\tau_c^* \dot{m}_c^*}, c_\beta = \frac{\beta}{2\tau_c^*} \gamma_U$$

$$\dot{m}_h^* = 0.1083 \text{kg.s}^{-1}, \dot{m}_c^* = 0.1803 \text{kg.s}^{-1}, \tau_h^* = 7.7392 \text{s},$$

$\tau_c^* = 8.3502 \text{s}$ are parameters depending on the particular heat exchanger.

We introduce the parameter γ_U which satisfies :

$$\gamma_u = \frac{\dot{m}_h \dot{m}_c^y}{\dot{m}_h^* \dot{m}_c^*} \frac{\dot{m}_c^{*y} + e \dot{m}_h^{*y}}{\dot{m}_c^y + e \dot{m}_h^y}$$

$y = 0.8$ and $e = \frac{A_h K_h}{A_c K_c} \approx 1.11$ are parameters representing the relative regime of flow and depend on heat geometry.

Thanks to data supplied by chemists, we know the various domains of variation of following variables :

$$\alpha, \beta \in 0, 2 ; T_{h,i}, T_{c,i} \in 0.4, 1 ; \dot{m}_h, \dot{m}_c \in 0.4, 1$$

Finally, we can notice that the model is nonlinear or more precisely bilinear.

The problem is to estimate the parameters α et β by using input/output data of the developed model. We will see various solutions brought this problem.

3. OBSERVER BASED ON ALGEBRAIC LYAPUNOV EQUATIONS AND INEQUALITIES

We start by rewriting the system in the following form:

$$\begin{cases} \dot{x} = A u x + F \alpha, \beta x + b u, \alpha, \beta + B u \\ \dot{\alpha} = 0 \\ \dot{\beta} = 0 \\ y = Cx \end{cases} \quad (6)$$

$$\text{With: } x = \begin{pmatrix} T_{h,1} & T_{h,2} & T_{c,1} & T_{c,2} \end{pmatrix}^T$$

$$A u = \begin{pmatrix} -u_2 & 0 & 0 & 0 \\ u_2 & -u_2 & 0 & 0 \\ 0 & 0 & -u_4 & 0 \\ 0 & 0 & u_4 & -u_4 \end{pmatrix}$$

$$F \alpha, \beta = \gamma \begin{pmatrix} -\alpha & 0 & \alpha & \alpha \\ -\alpha & -\alpha & \alpha & 0 \\ \beta & \beta & -\beta & 0 \\ \beta & 0 & -\beta & -\beta \end{pmatrix}$$

$$b u, \alpha, \beta = \begin{pmatrix} -\gamma \alpha u_1 \\ \gamma \alpha u_3 \\ -\gamma \beta u_3 \\ \gamma \beta u_1 \end{pmatrix} \quad B u = \begin{pmatrix} u_2 u_1 \\ 0 \\ u_4 u_3 \\ 0 \end{pmatrix}$$

$$C = \begin{pmatrix} 0 & 1 & 0 & 0 \\ 0 & 0 & 0 & 1 \end{pmatrix}$$

To simplify the writing of (5) we set:

$$\gamma = \gamma_u \quad \text{and} \quad u = \begin{pmatrix} T_{h,in} & T_{c,in} & \dot{m}_h & \dot{m}_c \end{pmatrix}^T$$

$$u_1 = T_{h,in}, u_2 = c_h, u_3 = T_{c,in}, u_4 = c_c, \alpha = \frac{\alpha}{2\tau_h}, \beta = \frac{\beta}{2\tau_c}$$

The proposed observer takes the following form :

$$\begin{cases} \dot{\hat{x}} = A u + F \hat{\alpha}, \hat{\beta} \hat{x} + b u, \hat{\alpha}, \hat{\beta} + B u \\ \quad + K u, \hat{\alpha}, \hat{\beta} y - C \hat{x} \\ \quad \dot{\hat{\alpha}} = g_1 u, y, \hat{x} \\ \quad \dot{\hat{\beta}} = g_2 u, y, \hat{x} \\ \quad \hat{y} = C \hat{x} \end{cases} \quad (7)$$

where:

- the gain $K u, \hat{\alpha}, \hat{\beta}$, depends on the inputs and fouling parameters is chosen such that $A u + F \hat{\alpha}, \hat{\beta} - K u, \hat{\alpha}, \hat{\beta} C$ is stable.

- the functions $g_1 u, y, \hat{x}$ and $g_2 u, y, \hat{x}$ are to be determined.

In what follows the methodologies employed for deriving the above gains and functions are presented.

3.1 Computation of $K u, \hat{\alpha}, \hat{\beta}$

We choose $K u, \hat{\alpha}, \hat{\beta}$ such that the following Lyapunov inequality is satisfied:

$$\begin{aligned} & A u + F \hat{\alpha}, \hat{\beta} - K u, \hat{\alpha}, \hat{\beta} C + \\ & A u + F \hat{\alpha}, \hat{\beta} - K u, \hat{\alpha}, \hat{\beta} C^T < 0 \end{aligned} \quad (8)$$

For this, we choose:

$$K u, \hat{\alpha}, \hat{\beta} = \begin{pmatrix} k_1 & k_2 & k_3 & k_4 \\ k_5 & k_6 & k_7 & k_8 \end{pmatrix}^T$$

$$\text{With } k_1 = u_2 - \hat{\alpha}\gamma ; k_3 = k_5 = \hat{\alpha}\gamma + \hat{\beta}\gamma ;$$

$$k_6 = k_4 = 0 ; k_7 = u_4 - \hat{\beta}\gamma ; k_2, k_8 > 0$$

Some gains (whenever possible) will be fixed to 0 in order to simplify the matrix and to make it easier to search other gains while satisfying (8) at the same time. Note here that we basically tried to have all the terms on the diagonal negative in our case, in our domain of variation of variables. Indeed, the choice of K matrix satisfied (8) because in our case α and β are positives.

3.2 Determination of functions $g_1 u, y, \hat{x}$ and $g_2 u, y, \hat{x}$

In order to derive the functions $g_1 u, y, \hat{x}$ and $g_2 u, y, \hat{x}$, we compute the dynamical errors of the observer:

$$\varepsilon = x - \hat{x} \quad \text{and} \quad \xi = \begin{pmatrix} \xi_1 \\ \xi_2 \end{pmatrix} = \begin{pmatrix} \alpha - \hat{\alpha} \\ \beta - \hat{\beta} \end{pmatrix} \quad (9)$$

It can be shown that:

$$\begin{aligned} \dot{\varepsilon} = & A u + F \hat{\alpha}, \hat{\beta} - K u, \hat{\alpha}, \hat{\beta} C \varepsilon \\ & + F \alpha, \beta - F \hat{\alpha}, \hat{\beta} x + b u, \alpha, \beta - b u, \hat{\alpha}, \hat{\beta} \end{aligned} \quad (10)$$

Due to the special form F , one can observe that:

$$F \alpha, \beta - F \hat{\alpha}, \hat{\beta} = F \xi_1, \xi_2$$

$$b u, \alpha, \beta - b u, \hat{\alpha}, \hat{\beta} = b u, \xi_1, \xi_2$$

Consequently, we obtain the following dynamical errors:

$$\begin{cases} \dot{\varepsilon} = A u + F \hat{\alpha}, \hat{\beta} - K u, \hat{\alpha}, \hat{\beta} C \varepsilon \\ \quad + F \xi_1, \xi_2 x + b u, \xi_1, \xi_2 \\ \dot{\xi}_1 = -g_1 u, y, \hat{x} \\ \dot{\xi}_2 = -g_2 u, y, \hat{x} \end{cases} \quad (11)$$

Now, let $V(\cdot)$ be the following Lyapunov function:

$$V \varepsilon, \xi = \varepsilon^T \varepsilon + \gamma \xi^T \xi \quad (12)$$

We shall determine the functions g_1 and g_2 such that

$$\dot{V} \varepsilon, \xi < 0 \quad (13)$$

From the above inequalities, there exist Q and S symmetric positive definite such that:

$$A u + F \hat{\alpha}, \hat{\beta} - K u, \hat{\alpha}, \hat{\beta} C + A u + F \hat{\alpha}, \hat{\beta} - K u, \hat{\alpha}, \hat{\beta} C^T = -Q$$

Consequently,

$$\begin{aligned} \dot{V} \varepsilon, \xi &= \varepsilon^T \dot{\varepsilon} + \dot{\xi}^T \varepsilon + \gamma \xi^T \dot{\xi} + \gamma \dot{\xi}^T \xi \\ &= -\varepsilon^T Q \varepsilon + 2\varepsilon^T F \xi_1, \xi_2 x + 2\varepsilon^T b + 2\gamma \xi^T \dot{\xi} \end{aligned} \quad (14)$$

By developing the term, $2\varepsilon^T F \xi_1, \xi_2 x + 2\varepsilon^T b + 2\gamma \xi^T \dot{\xi}$ we get:

$$\begin{aligned} &2\varepsilon^T F x + 2\varepsilon^T b + 2\gamma \xi^T \dot{\xi} \\ &= 2\gamma \xi_1 \dot{\xi}_1 + \varepsilon_2 u_3 - \varepsilon_2 x_2 + 2\gamma \xi_2 \dot{\xi}_2 + \varepsilon_4 u_1 - \varepsilon_4 x_4 \\ &\quad + 2\gamma -x_1 \varepsilon_1 + x_3 \varepsilon_1 + x_4 \varepsilon_1 - x_1 \varepsilon_2 + x_3 \varepsilon_2 \xi_1 \\ &\quad + 2\gamma x_1 \varepsilon_3 + x_2 \varepsilon_3 - x_3 \varepsilon_3 + x_1 \varepsilon_4 - x_3 \varepsilon_4 \xi_2 \\ &\quad - 2\gamma \varepsilon_1 u_1 \xi_4 + \varepsilon_3 u_3 \xi_2 \end{aligned} \quad (15)$$

$$\text{Next, we set } \dot{\xi}_1 + \varepsilon_2 u_3 - \varepsilon_2 x_2 = 0 \text{ et } \dot{\xi}_2 + \varepsilon_4 u_1 - \varepsilon_4 x_4 = 0.$$

so that

$$\begin{cases} \dot{\xi}_1 = \varepsilon_2 -u_3 + x_2 \\ \dot{\xi}_2 = \varepsilon_4 -u_1 + x_4 \end{cases} \quad (16)$$

Recalling that $\dot{\xi}_1 = -\dot{\hat{\alpha}}$ et $\dot{\xi}_2 = -\dot{\hat{\beta}}$, we obtain the expression of g_1 and g_2 :

$$\hat{\alpha} = \varepsilon_2 u_3 - x_2 = y_1 - \hat{x}_2 u_3 - x_2 = g_1 u, y, \hat{x} \quad (17)$$

$$\hat{\beta} = \varepsilon_4 u_1 - x_4 = y_2 - \hat{x}_4 u_1 - x_4 = g_2 u, y, \hat{x}$$

The remaining terms $-2\gamma \varepsilon_1 u_1 \xi_4 + \varepsilon_3 u_3 \xi_2 < 0$, $2\gamma -x_1 \varepsilon_1 + x_3 \varepsilon_1 + x_4 \varepsilon_1 - x_1 \varepsilon_2 + x_3 \varepsilon_2 \xi_1$ and

$2\gamma x_1 \varepsilon_3 + x_2 \varepsilon_3 - x_3 \varepsilon_3 + x_1 \varepsilon_4 - x_3 \varepsilon_4 \xi_2$ can be bounded by a term of the form $c_1 \|\varepsilon\| \|\xi\|$ where $c_1 > 0$.

Also,

$$2\|\varepsilon\| \|\xi\| \leq \rho \|\varepsilon\|^2 + \frac{1}{\rho} \|\xi\|^2 \quad (18)$$

with $\rho > 0$

Hence,

$$\dot{V} \varepsilon, \xi \leq -\lambda_{\min} Q \|\varepsilon\|^2 + c\rho \|\varepsilon\|^2 + \frac{c}{\rho} \|\xi\|^2 \quad (19)$$

$$\dot{V} \varepsilon, \xi \leq -\lambda_{\min} Q -c\rho \|\varepsilon\|^2 + \frac{c}{\rho} \|\xi\|^2 \quad (20)$$

To have the error converge to 0 and $\dot{V} \varepsilon, \xi < 0$, we choose the gains k_2, k_8 large to minimise the influence of ρ in order to obtain $\lambda_{\min} Q > c\rho$. We can choose the constant ρ large enough to minimise the effect of $\|\xi\|$.

Finally accounting for different constraints on the gains previously discussed, we obtain an asymptotic observer given by:

$$\begin{aligned} \dot{\hat{x}}_1 &= u_2 u_1 - \hat{x}_1 + \gamma_u \hat{\alpha} \hat{x}_3 + \hat{x}_4 - \hat{x}_1 - u_1 + u_2 - \gamma_u \hat{\alpha} y_1 - \hat{x}_2 + \gamma_u \hat{\alpha} + \hat{\beta} y_2 - \hat{x}_4 \\ \dot{\hat{x}}_2 &= u_2 \hat{x}_1 - \hat{x}_2 + \gamma_u \hat{\alpha} - \hat{x}_1 - \hat{x}_2 + \hat{x}_3 + u_3 + k_2 y_1 - \hat{x}_2 \\ \dot{\hat{x}}_3 &= u_4 u_2 - \hat{x}_3 + \gamma_u \beta \hat{x}_1 + \hat{x}_2 - \hat{x}_3 - u_3 + \gamma_u \hat{\alpha} + \hat{\beta} y_1 - \hat{x}_2 + u_4 - \gamma_u \hat{\beta} y_2 - \hat{x}_4 \\ \dot{\hat{x}}_4 &= u_4 \hat{x}_3 - \hat{x}_4 + \gamma_u \beta \hat{x}_1 - \hat{x}_3 - \hat{x}_4 + u_1 + k_8 y_2 - \hat{x}_4 \\ \dot{\hat{\alpha}} &= u_3 - y_1 y_1 - \hat{x}_2 \\ \dot{\hat{\beta}} &= u_1 - y_2 y_2 - \hat{x}_4 \end{aligned} \quad (21)$$

with $k_2, k_8 > 0$.

3.3 Simulations result

The simulation is realized on 2 drifts used in [Jonsson et al. (2007)] and [Lalot et al.(2007)]. The first drift lasts 54644s and the second lasts 28880s. For the two drifts, the fouling begins about two third of the drift stay. The inputs of the heat exchanger are chosen random. The fouling is the same for the two drifts and is represented on the Figure 3. This parameter does not appear in the model described by (3) ; but it is used during the simulation by the Fluent software [Fluent]. The relation between the fouling factor and both α and β is complex but the fouling factor is roughly proportional to $\frac{1}{\hat{\alpha}} + \frac{1}{\hat{\beta}}$.

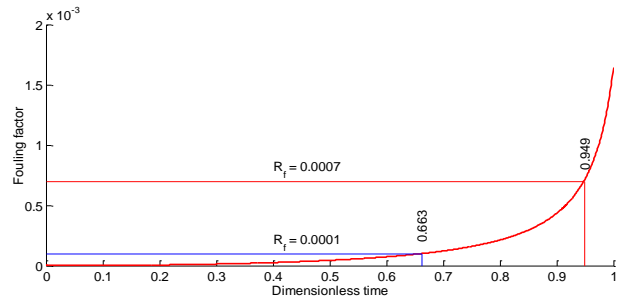

Fig. 3. Fouling factor for the two drifts

The fouling is modified thanks to the variation of the parameters c_h and c_c . For the observation of parameters relation to the fouling, the both drifts will be presented with a normalized unitary time scale in order to compare results. Figure 4 shows the profile of the estimation of parameter $\hat{\alpha}$ and Figure 5 that of the parameter $\hat{\beta}$.

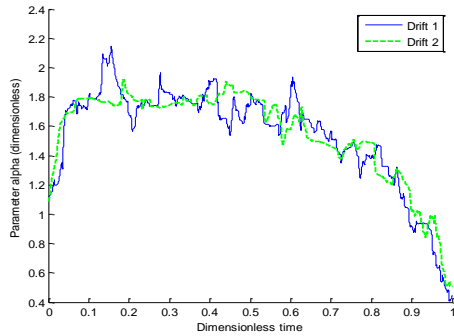

Fig. 4. Estimation of $\hat{\alpha}$ on two drifts.

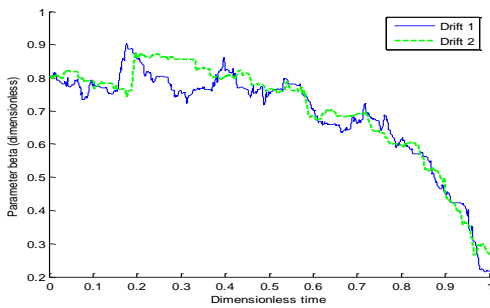

Fig. 5. Estimation of $\hat{\beta}$ on two drifts

One can see that the both drifts are similar. We can say that this method performs well on various data. To check if the results follow the reality, we compare the known real temperature data obtained from a laboratory heat exchanger (the output temperatures of the heat exchanger) with the estimated temperatures on the second drift. This comparison takes place on the second drift.

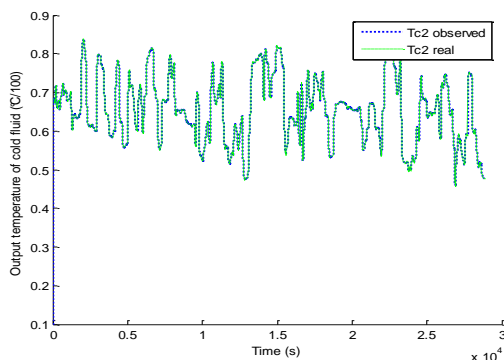

Fig. 6. Comparison of the output temperature of cold fluid of real system and the observer on the second drift.

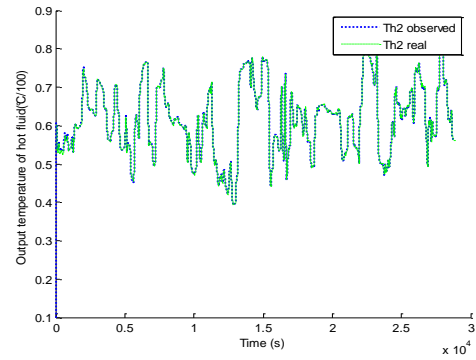

Fig. 7. Comparison of the output temperature of hot fluid of real system and the observer on the second drift.

We can note that the both temperatures have similar profile, showing that the observer works well. From Figures 8 and 9, we can see that the relative errors of these temperatures are negligible, they are less than 2.5 %.

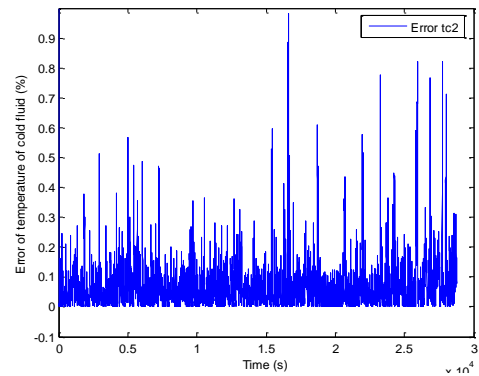

Fig. 8. Relative error between the temperature of the output cold fluid of the real system and the estimated temperature of the observer.

We can see, in the Figure 10, the term :

$\frac{1}{\hat{\alpha}} + \frac{1}{\hat{\beta}}$, follows a similar pattern to the fouling pattern shown in Figure 3.

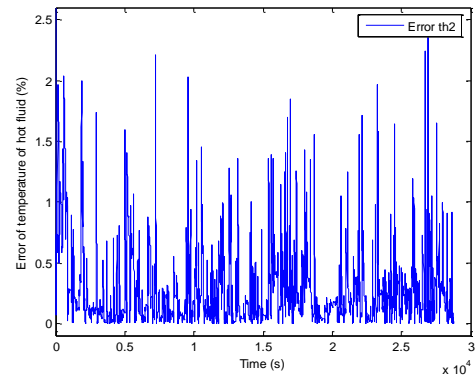

Fig. 9. Relative error between the temperature of the output hot fluid of the real system and the estimated temperature of the observer.

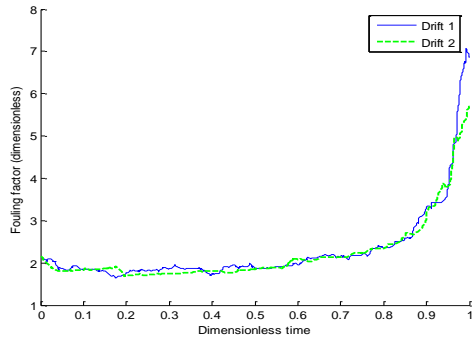

Fig. 10. Fouling factor for the two drifts.

We note that the fouling begin as we wished namely 2/3 of the simulation. The results of the both drifts are equivalent and are similar to Figure 3, representing the fouling. Consequently, we can conclude that the fouling is detectable using this observer method.

In Figure 11 a comparative results is shown using the proposed observer and that proposed [Delmotte et al. (2008)].

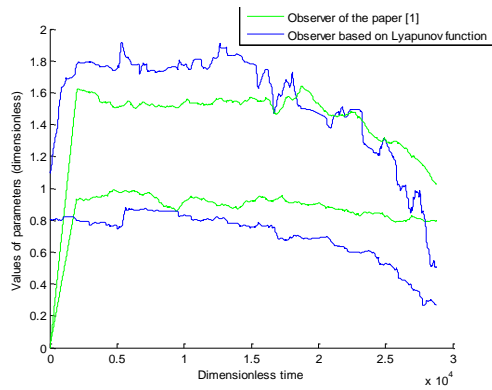

Fig. 11. Parallel between this method and the method see into [Delmotte et al. (2008)].

We can see that the curves of α and β decreases considerable as a of fouling whereas in the results of paper [Delmotte et al. (2008)], only α decreases at the end of simulation. Moreover, [Delmotte et al. (2008)] use a filter after the simulation of the set of observer whereas our method uses only one observer and without any filter.

4. CONCLUSIONS

This paper presented a new technique for the detection of the fouling in a heat exchanger. The observer is designed by exploiting the bilinear structure of a simplified model of the heat exchanger. Suitable Lyapunov equations and functions are used to obtain the gain of the observer. The good performance of the observer in detecting the fouling is shown via simulation using real data obtained from a laboratory heat exchanger.

KNOWLEDGMENT

This work has been supported by International Campus on Safety and Intermodality in Transportation, the European Community, the Delegation Regionale a la Recherche et a la

Technologie, the Ministere de l'Enseignement superieur et de la Recherche, the Region Nord Pas de Calais and the Centre National de la Recherche Scientifique.

REFERENCES

- Delmotte F., Delrot S., Lalot S. et Dambrina M. Fouling Detection in Heat Exchangers with Fuzzy Models. 19th International Symposium on Transport Phenomena, Iceland, 15-18 august 2008.
- Delrot S., Busawon K., Djemai M., Delmotte F. Fouling detection in the heat exchangers. 6^{eme} Conférence Internationale Francophone d'Automatique, CIFA 2010, Nancy, France, 2-4 juin 2010.
- Hammouri, H.; Kabore, P.; Kinnaert, M.; "A geometric approach to fault detection and isolation for bilinear systems", IEEE Transactions on Automatic Control, Volume 46, Issue 9, Sept. 2001 Page(s):1451 – 1455.
- Hammouri, H.; Kabore, P.; Othman, S.; Biston, J. "Failure diagnosis and nonlinear observer. Application to a hydraulic process", in Journal of The Franklin Institute Volume: 339, Issue: 4-5, July - August, 2002, pp. 455-478.
- Jonsson G. R. Parameter estimation in models of heat exchangers and geothermal reservoirs. Ph.D. thesis, Department of Mathematical Statistics, Lund Institute of Technology, 1990.
- Jonsson G. R., Lalot S., Palsson O. P. et Desmet B. Use of extended Kalman filtering in detecting fouling in heat exchangers. International Journal of Heat and Mass Transfer, Vol. 50, pp. 2643-2655, 2007.
- Kabore, R.; Wang, H.; "Design of fault diagnosis filters and fault-tolerant control for a class of nonlinear systems", IEEE Transactions on Automatic Control, Volume 46, Issue 11, Nov. 2001 Page(s):1805 – 1810.
- Kinnaert, M.Michel, "Robust fault detection based on observers for bilinear systems", in Automatica Volume: 35, Issue: 11, November, 1999, pp. 1829-1842.
- Lalot S., Palsson O. P., Jonsson G. R. et Desmet B. Comparison of neural networks and Kalman filters performances for fouling detection in a heat exchanger. International Journal of Heat Exchangers, Vol VIII, 1524-5608, pp. 151-168, 2007.
- Wolverine Tube, Inc. Wolverine engineering databook II. Electronic distribution, Research and development team, 2001.
- Fluent Flow Modeling Software, at <http://www.fluent.com/software/fluent/index.htm>.

APPENDIX

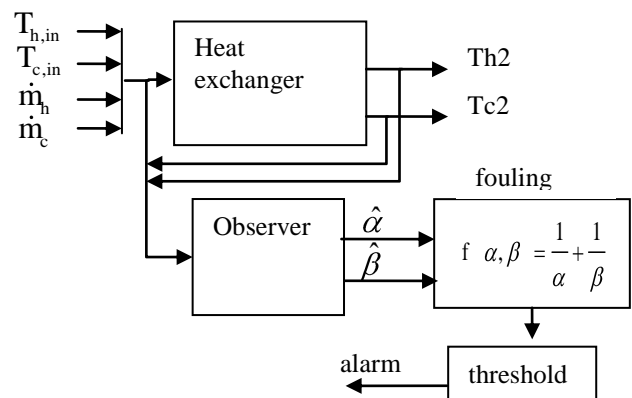

Fig. A.1 Block diagram of the Heat exchanger