

Northumbria Research Link

Citation: English, Stuart and Conti, Matteo (2010) Ultra Low Carbon Vehicles: New Parameters for Automotive Design. In: Design Research Society International Conference, 7-9 July 2010, Montréal, Canada.

URL:

This version was downloaded from Northumbria Research Link:
<http://nrl.northumbria.ac.uk/12179/>

Northumbria University has developed Northumbria Research Link (NRL) to enable users to access the University's research output. Copyright © and moral rights for items on NRL are retained by the individual author(s) and/or other copyright owners. Single copies of full items can be reproduced, displayed or performed, and given to third parties in any format or medium for personal research or study, educational, or not-for-profit purposes without prior permission or charge, provided the authors, title and full bibliographic details are given, as well as a hyperlink and/or URL to the original metadata page. The content must not be changed in any way. Full items must not be sold commercially in any format or medium without formal permission of the copyright holder. The full policy is available online: <http://nrl.northumbria.ac.uk/policies.html>

This document may differ from the final, published version of the research and has been made available online in accordance with publisher policies. To read and/or cite from the published version of the research, please visit the publisher's website (a subscription may be required.)

www.northumbria.ac.uk/nrl



Ultra Low Carbon Vehicles: New Parameters for Automotive Design

Stuart. G. English, Northumbria University, United Kingdom

Matteo Conti, Northumbria University, United Kingdom

Abstract

As the influence of vehicle emissions on our environment has become better understood, the UK government has recently placed urgent emphasis on the implementation of low carbon technologies in the automotive industry through: the UK Low Carbon Industrial Strategy. The overall objective is to offer big incentives to consumers and support for the development of infrastructure and engineering solutions. This scheme however does not consider how the development of functional and experiential user value might drive consumer demand, contributing to the adoption of low carbon vehicles (LCVs) in the mass market.

With the emergence of the North East of England as the UK's first specialised region for the development of ultra-low carbon vehicles (ULCVs), ONE North East, as a development agency for the region's economic and business development, and Northumbria University Ideas-lab have supported a project to facilitate innovation through the collaboration of technology, research and development (R&D) and business. The High Value Low Carbon (HVLC) project aims to envisage new user value made possible by the integration of low carbon vehicle platforms with new process and network technologies. The HVLC consortium represents vehicle manufacturers and their suppliers as well as technology based companies and through an ongoing process of design concept generation the project offers a hub for innovation led enterprise.

Whilst new technological developments in areas such as power generation, nano materials, hydrogen fuel cells, printed electronics and networked communications will all impact on future automotive design, the mass adoption of low carbon technologies represents a paradigm shift for the motorist. This paper aims to describe how the mapping of new parameters will lead to new transport scenarios that will create the space for new collaborative research on user experiences supported by innovative technologies and related services.

Keywords

automotive design; low carbon; transport scenarios; sustainable design; user value.

In the late nineteenth Century the fastest cars in the world were electric. These vehicles reached over 65 mph, speeds not surpassed by fuel based cars until the early twentieth century. Since then over 100 years of improvement and innovation in the automotive industry has been focused predominantly on internal combustion vehicles that are responsible for the production of around a quarter of the UK's emissions of carbon dioxide (*Why is the car industry failing on climate change?*, n.d.). Today's car market, in developed countries, is about to undergo a cultural revolution that will open up new and promising scenarios for ULCVs (hybrid and totally electric vehicles) as we mainly utilise our cars in towns limited to daily mileages of less than 40 miles (*Pininfarina Bluecar*, n.d.).

Since the latest car power trains do not offer yet a significant combined reduction of CO₂ emissions and fuel consumption over frugal diesel engines, as proven by some motor journalists (*Toyota Prius proves a gas guzzler in a race with the BMW 520d*, Rufford N., & Dawe J.), global competition remains wide open to create more capable and efficient vehicles to protect our global environment. Due to the massive investment required to create a traditional new vehicle, as Tata invested nearly \$400 million in the Nano (*Tata: Still Reeling from Its Jaguar-Land Rover Buy*, Srivastava M.), advanced and economical power train technologies can enable even smaller companies to enter the LCV market by converting mainstream vehicles into the next generation of lean and efficient vehicles. IDTECHEX car analysts state that by 2020, it will be possible for some suppliers to offer hybrid cars and no price premium to conventional cars making a strong case why anyone would want the conventional alternative (*Hybrid And Pure Electric Cars 2009-2019*, n.d.).

Within this highly technological and thriving context the HVLC project's drive is to obtain a share of this market as a consortium in order to provide design and engineering solutions through innovation and enhanced user value. It is worth noting that this represents a fundamental step for designers to embrace sustainable design through appropriate industrial collaboration in this emerging field, as the opportunity to innovate and drive the evolution of ultra low carbon vehicles in many aspects is going to modify the way we perceive and use cars, as refined products, but also make a real contribution towards lowering our road transport emissions on a large scale. In fact, it is expected this transportation revolution will account for 1.5-2 million electric vehicles (EVs) introduced in the medium term on the European market alone (*Pininfarina Bluecar*, n.d.).

The HVLC's agenda follows the same guidelines that Peter Mandelson, Secretary of State for Business, Innovation and Skills, and Ed Miliband, MP and Secretary of State, Department of Energy and Climate Change (*The UK Low Carbon Industrial Strategy*, July 2009) recently stated: 'The global market for low carbon goods and services is already worth around £3 trillion a year, and will probably grow by half that again by 2015'.

History of Electric Vehicles

Electric vehicles have been a neglected and side lined from the car makers' development and business agenda for nearly a century. This is apparent as EVs rarely feature in car history books. HVLC conducted some preliminary research to comprehend the whole evolution of EVs and then chronologically summarised it in table 1 and 2 by highlighting the most significant EVs' milestones.



<p>1832-1839 First Cell Vehicle Scottish inventor Robert Anderson invents the first crude electric carriage powered by primary cells.</p>	<p>1891 First Successful EVs William Morrison builds first successful electric automotive in the US.</p> <p>1897 First Electric Taxi The new vehicle hits the streets in this year. The Pope Manufacturing Company of Connecticut becomes the first mainstream American electric automotive manufacturer.</p> <p>1899 First Land Speed Records Three records set in one year 57.6mph – highest</p>	<p>1912 Charging Stations Thomas Edison and Henry Ford decided to work together to make the electric car the main transportation in the US. Their goal was to have charging stations where people could "fill up" their cars around the country.</p> <p>1912 First Electric Starter Charles Kettering invents the first practical electric starter motor for the internal combustion engine, helping the beginning of its evolution.</p>
		
<p>1832-1839 First primary cell vehicle</p>	<p>1899 First EV land speed records</p>	<p>1912 Thomas Edison's EV</p>
<p>The Global Warming Time Line</p>		
<p>1841 Newspapers report Jean Baptiste Joseph Fourier's theory of global warming. However, many believe that the warming of the earth is a positive development.</p>	<p>1894 Newspapers reflect on the past decade that brought about a revolution in labour industries. During the c20th, scientists will mark this time period as the beginning of the industrial pollution of the environment</p>	<p>1913-1914 Swedish scientist Svente Arrhenius coins the term "greenhouse effect" and predicts that the slow warming of the Earth's climate. Many scientists dismiss the possibility of the theory. Arrhenius' prediction sparks speculation about the end of the world.</p>

Table 1 the electric vehicle stepping stones – From its origin until the first world war

1971 Apollo 17

Lunar Rover (19 April) was the first vehicle on the moon.

1972 First Hybrid

Victor Wouk, (Godfather of the Hybrid), builds first full-powered, full size hybrid vehicle based on a 1972 GM Buick Skylark.

1974 Vanguard-Sebring Citi Car

Debuts at the Electric Vehicle Symposium, Washington DC.



1974
Vanguard-Sebring Citi Car

1996 GM EV1

The first modern production electric vehicle from a major automaker and also the first purpose-built electric car produced by General Motors (GM) in the United States.

1997 Toyota Prius

Toyota unveils world's first commercial mass-produced and marketed hybrid car in Japan



1996
GM EV

2000

A few thousand all-electric cars (eg. Honda EV Plus, GM EV1, Ford Ranger pickup EV, Nissan Altra EV, Chevy S-10 EV, and Toyota's RAV4 EV) are produced by big car manufacturers, but are mostly available for lease only.

2006

A few pure electric cars and plug-in hybrids are in limited production, with new ones are on the horizon.



2002
Tesla Roadster

The Global Warming Time Line

1950-1970

Development of new technology leads to an increased awareness about global warming and the greenhouse effect. New studies show that the level of carbon dioxide in the atmosphere is rising each year and pollution concerns begin to enter into everyday life.

1984-1990

Theories about the greenhouse effect and global warming become more prevalent, and gain attention from mass media. However, many people believe the threat is not eminent and some doubt that global climate change is a danger.

1997-2005

Worldwide conference on Global warming is held in Kyoto, Japan on December 1st 1997. 125 nations sign the Kyoto Protocol, committing to reduce pollution.

Table 2 The electric vehicle stepping stones – from the 1970s to date

Current Context

Global environment

As a result of more than 150 years of industrial activity, the amount of carbon dioxide in the Earth's atmosphere and temperatures have been rising dramatically because of the pollution caused by burning fossil fuels and the unstoppable deforestation process. It follows that glaciers are melting, plants and animals are being forced from their habitats, and the number of severe hurricanes, storms and droughts is increasing (*What is global warming?*, n.d.).

Now that the Obama administration has ratified the Kyoto protocol, whose key aim is to reduce greenhouse gas (GHG) emissions to an average of 5 % against 1990 levels over the five-year period 2008-2012 (*Kyoto Protocol*, n.d.), there is rightly an increasing pressure to embrace low carbon technologies. It must be also pointed out that the global car industry has overtly and covertly delayed the R&D of fuel efficient technology as well as non-fossil fuel based vehicles. Both the government and the car industry have realised that the dependence on non-renewable fuel sources is an area that needs addressing with a certain degree of urgency.

In order to tackle this difficult situation the European Commission has currently proposed to its member states to promote and stimulate the purchase of fuel-efficient vehicles and to invest in more research aimed at reducing car emissions to an average of 95g CO₂/km by 2020 (*CO₂ and Cars*, n.d.). This is absolutely necessary since the transportation sector is a major contributor of GHG, as shown in figure 1, and because no nation can avoid the serious consequences of climate change.

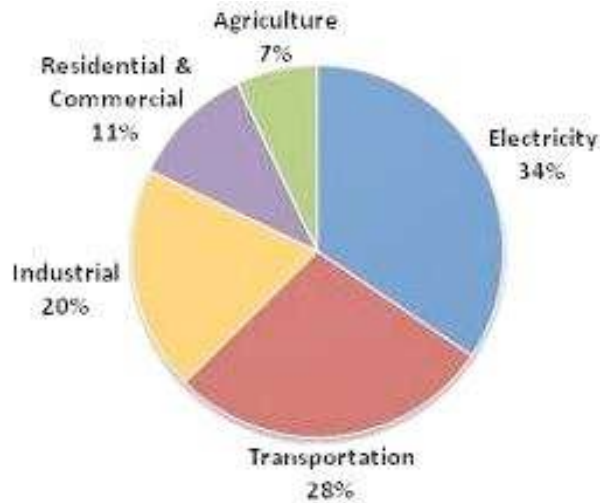

Figure 1 U.S. greenhouse gas emissions by economic sector (2007)

In order to further reduce global warming, in the next few decades, the world's energy systems will have to be transformed so that global emissions drop 50 to 80% (*World Development report 2010*, n.d.). This enormous challenge must be met by the transportation industry as well if we are to minimise the effects of global warming.

Government LCV Strategy

The UK government has recognised the need for research into LCVs technology and has accordingly responded by investing into three main areas:

1. Engineering: £23 million for low carbon vehicle innovation platform - phase 1.
2. Infrastructure: £100 million for low carbon vehicle integrated delivery programme £20 million for LCV public procurement programme.
3. Incentive: £250 million for the DfT EV consumer incentive package encourages consumers to buy electric by providing a £2000 - £5000 subsidy for low carbon vehicles.

The government has also recently released a projected scenario of personal transportation in the UK over the next 40 years, as illustrated in figure 2.

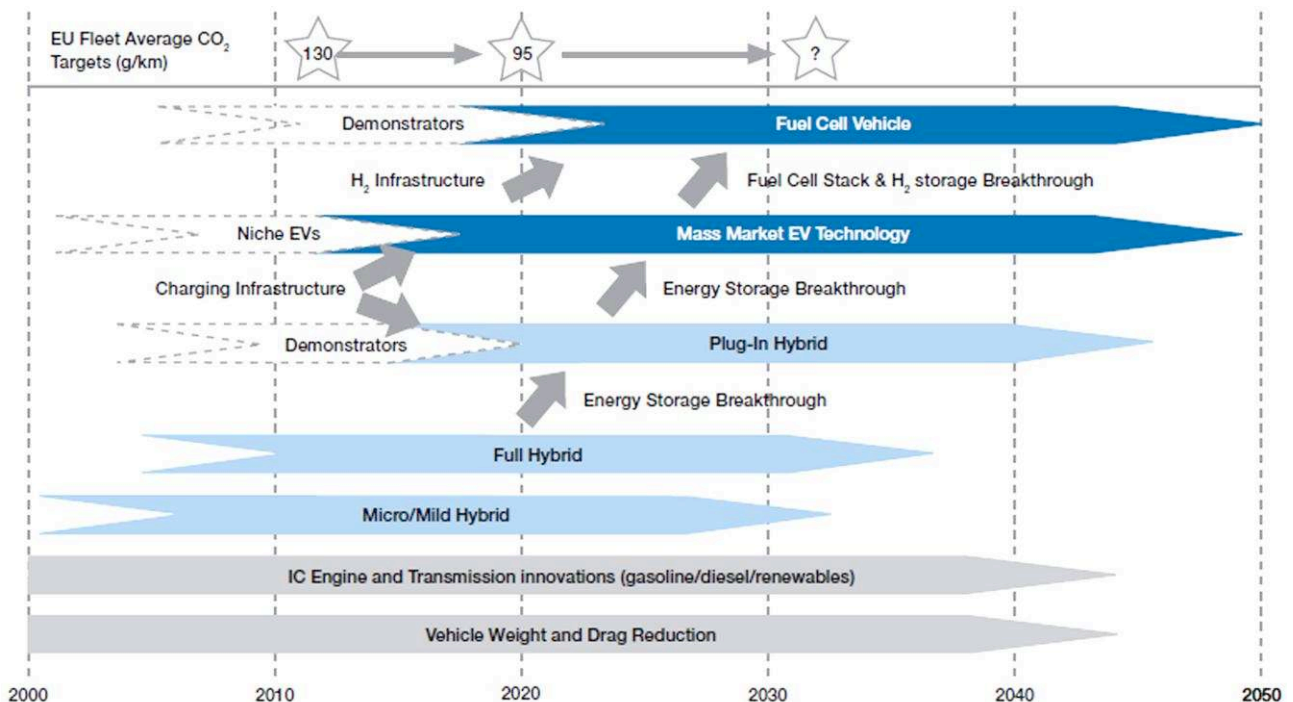

Figure 2 High-level technology roadmap for the UK's decarbonisation of road transport

The chart illustrates an unprecedented parallel development of different power train technologies. It also unmistakably points out how complex, varied and also uncertain will be the future car market, as various advanced LCV power trains will enter the market and become more competitive in terms of low emissions, energy consumption, reliability, and running costs. In addition, another major variable is represented by the subsequent development of adequate infrastructure through local governments to support those alternative means of transport and ensure they are a viable solution to tackle climate change. The complexity of this market will increase as over the next few years more obsolete and less efficient vehicles will be phased out leaving the consumer with a new wider spectrum of cars to choose from based on the user's needs and desires. It follows that styling, safety and branding will not be the only deciding factors in people's mind when it comes to acquiring a new vehicle.

Technology

As in the short term, none of these low carbon vehicle platforms will be resolved and mature enough to emerge from the other alternative power trains and set new standards, a lot of fierce competition between these propulsion systems developed by vehicle manufacturers and component makers will take place. This unusual phenomenon will offer car makers but also smaller design and engineering entities an opportunity to innovate and compete in the market place as the electrification of vehicles will significantly simplify vehicle assembly and procurement of components.

Analysts predict that electric vehicles will penetrate the market rapidly to constitute 35% of the cars made in 2025, 25% hybrids, 10% pure EVs (*Hybrid And Pure Electric Cars 2009-2019*, n.d). As a result, any motor manufacturer without a compelling line up of hybrid and full electric vehicles will be facing serious financial losses.

A recent study by the Swiss Federal Institute for Materials Science and Technologies has dismissed the pre-conceived idea, that driving an EV is simply relocating the problem to the production of electricity, by studying the entire life cycle of different modes of power for individual cars. Figure 3 illustrates the results of a comparison between an EV charged with the European electricity mix (mainly relying on thermal power plants), an EV charged with solar panels (renewable energy) and the usual combustion engine fuelled at the petrol station. Even in the case of the EU electricity mix, over 50% of the CO2 emissions are reduced (*The Bright Green Idea*, D. Rochat).

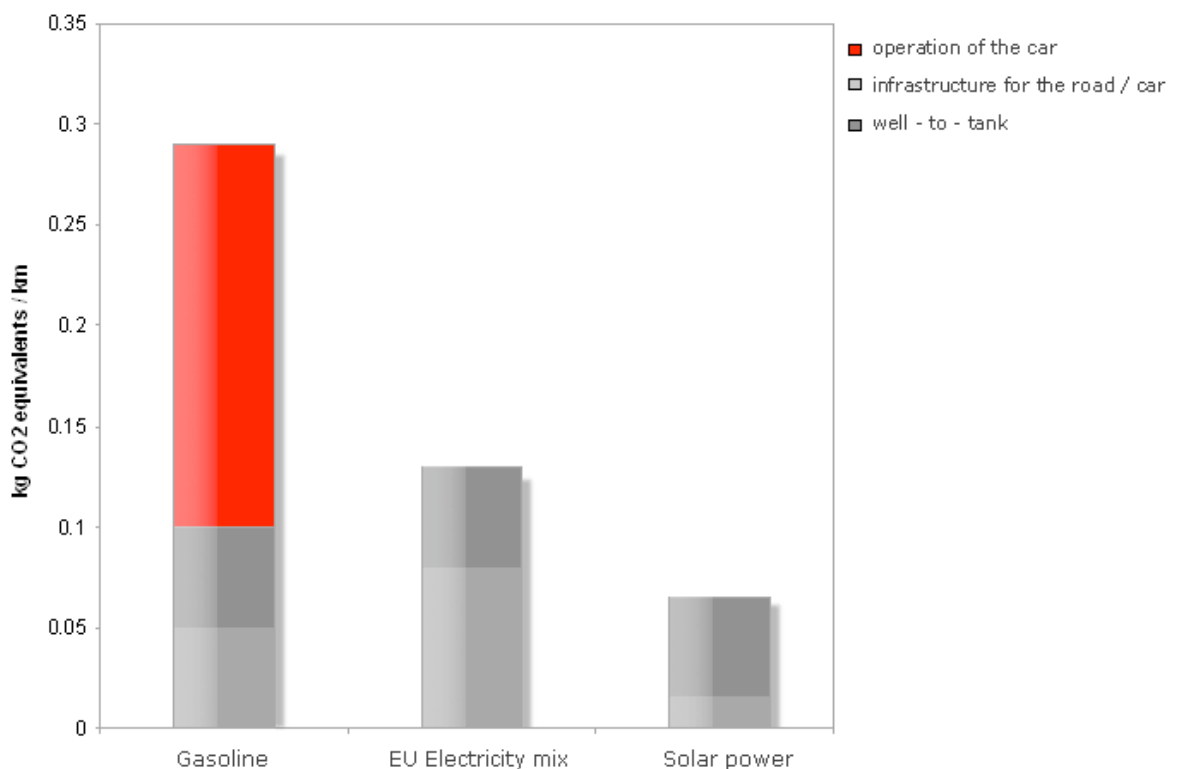

Figure 3 Comparison of greenhouse gas emitted for driving 1 km for three types of car

The High Value Low Carbon Project

HVLC Structure and Objectives

In response to the UK Government's focus on engineering and infrastructure the researchers have initiated a consortium-based project that aims to envisage functional and experiential user value made possible by the development of LCV technologies. The High Value Low Carbon (HVLC) consortium of industrial and research partners includes:

- 4 international automotive manufacturers
- 3 research centres
- 7 component manufacturers
- The regional development agency ONE North-East

By bringing together carefully selected organisations around the theme of LCV innovation, the consortium has enabled companies to interact and as a result a number of 'spin-off' commercial opportunities have been initiated. The aim of the project is:

- To provide a conceptual focus for an ongoing collaborative project involving technology companies and suppliers to the automotive industry.
- To develop high quality interior design concepts for future electric vehicles.
- To demonstrate how printable electronic technology can provide added value concepts in vehicle design.
- To explore the integration of hi-tech on-board info-entertainment equipment such as: screens, Internet enabled computer, mobile phones, cameras, etc.
- To provide a high level of security through the on-board Internet connection.
- To envisage additional user benefits made possible by battery technology.
- To pilot collaborative arrangements prior to the commencement of a substantial LCV project in 2010.
- To stimulate business activity and commercial collaboration.

Research questions

The aim to innovate and tackle the multi-faceted topic of EVs in an unbiased and rational manner led the HVLC team to formalise their reasoning through the identification of key research questions. As a result, the entire research project revolves around 4 fundamental enquiries that explore:

1. New intellectual property (IP).
2. New ideas for new products and services.
3. New methods and ways of thinking.
4. New knowledge about the sustainable future of the automotive industry.

These also represent the motives that drive the development of HVLC in a world where the struggling auto industry needs to seriously reconsider its priorities and product development strategies if it is to survive within future economic parameters.

Research method

The HVLC project is underpinned by a practical knowledge of transportation design and the automotive industry, the researchers being experienced transportation and industrial designers. Three third year BA (hons) transportation design students were employed on placement and the researchers directed their activities in support of the project.

A process of multiple perspective problem framing (English 2008) was adopted, firstly to explore parameters relevant to the development of viable LCV products and services. Secondly to describe potential user value revealed by the interrelationship of these parameters and thirdly, to explore potential opportunities for consortium companies to develop business collaboration (this has already led to a number of commercial 'spin offs' in other fields). Figure 4 shows an initial project-scoping map.

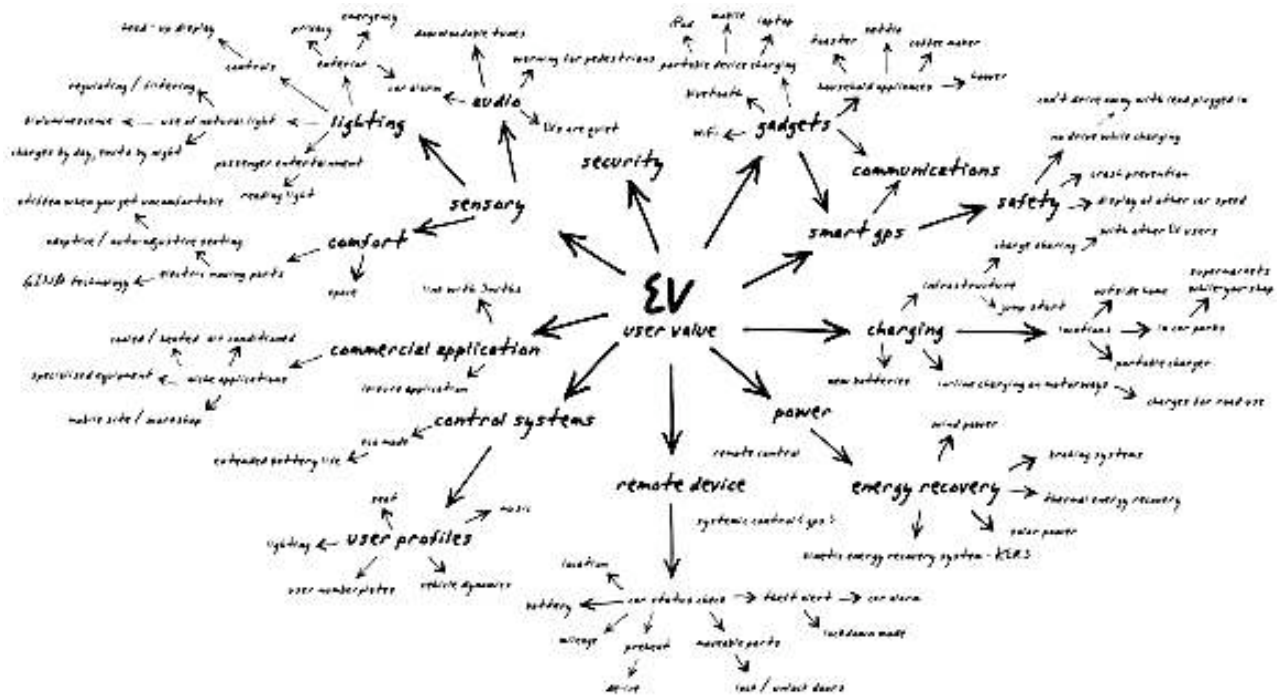

Figure 4: HVLC project-scoping map

This reflective tool was instrumental in the planning phase of the project as it provided the researchers with a clear appreciation of the design terrain and helped to compile the necessary background research to inform subsequent development of the chosen concept themes.

The research team organised regular monthly meetings with key personnel from collaborating organisations. Evolving concepts were presented with a view to stimulating dialogue across the consortium. The ensuing discussion was recorded and the issues arising fed the development of concepts as outlined below.

Project outcome

The following outcomes were achieved at the end of the project:

- A book describing new user benefits made possible by electric vehicle platforms in order to stimulate new business networks and commercial propositions.
- A showcase for new concepts made possible through the collaboration of technology companies and the automotive industry.
- A Presentation package and travelling exhibition used at the CENEX LCV ride and drive conference and exhibition at Millbrook vehicle proving grounds in September 2009.
- A dedicated website (www.highvaluelowcarbon.com) that operates as a hub for a consortium of companies engaged in collaborative low carbon initiatives.

Growth of the LCV market

The dynamics of the car market in developed countries are rapidly evolving as a number of major manufacturers like Honda, Toyota and Renault are launching fully electric (EVs) and hybrid vehicles (HEVs) on the market between 2010 and 2012. Lux Research's ongoing tracking of alternative power and energy storage opportunities found that in 2007, about 500,000 HEVs were sold, accounting for \$484M worth of batteries (*Business Wire*, 2008). Plug-in hybrid electric vehicles (PHEVs) and pure EVs are scheduled for introduction in 2010, driving the market for all light electric vehicles, including HEVs, PHEVs, and pure EVs, to 3M units in 2012, leading to a battery market of \$3.8B in that year. Although HEVs will continue to grow at 40% annually in the next five years, the next frontier is PHEVs, which need greater energy storage capacities to support longer all-electric ranges.

To further confirm this growth trend, BBC Research - Hybrid & Electric Vehicle Progress Review stated that the global market for large and advanced batteries increased from \$8.4B in 2006 to \$8.9B in 2007 and it should reach \$11.4B by 2012. Research & Markets is projecting a healthy

\$200M figure in annual US electric vehicle charging sales by 2015. These predicted figures provide a clear indication of the massive growth of the LCV industry which is still in its infancy and as such requires substantial funding and private investment to support its expansion.

EV Development

The development of the current and future ULCVs is represented by the introduction of EVs. The current obstacle in the EVs' technical evolution is strictly related to a complex series of technical factors which cannot be easily overcome without substantial R&D activities to evolve electric platforms within a well defined and widespread charging infrastructure. Other related parameters such as battery performance, light weight construction, vehicle range, etc. can be separately analysed but they would not necessarily provide a balanced account of the latest trends and challenges that the industry and society are currently facing. HVLC soon realised that the complexity of the EV development and its business success are dependent on a large number of variables which need to trigger other prerequisites in the right sequence to bring technical progress and as a result extensive mass production. Figure 5 shows this evolutionary cycle.

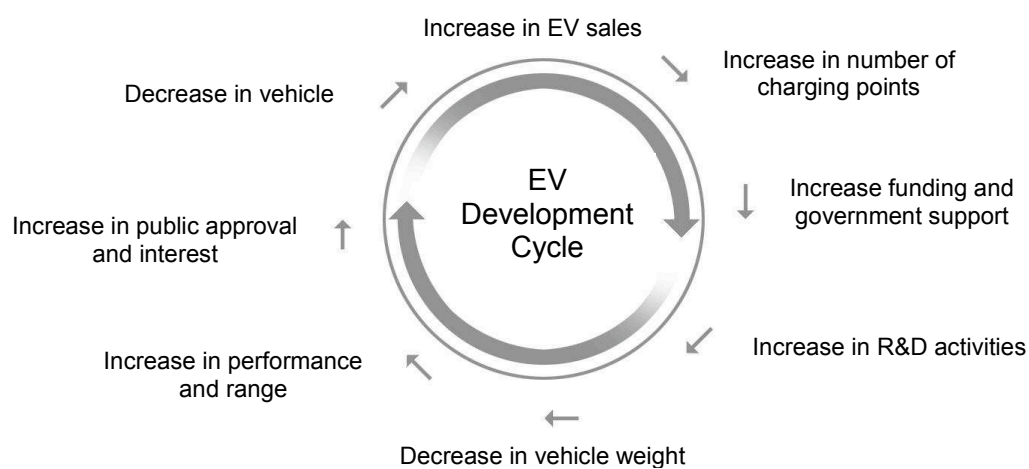

Figure 5 Electric vehicle development cycle

It is apparent that in order to sustain significant EV development and success in the car market some key technical aspects such as the increase of charging points and car range will play a major role. There is delicate balance of factors at play which is not only based on sheer engineering capability but also on design dexterity and marketing strategy to win public acceptance. Based on the government forecast, HVLC started its pilot project in May 2009 by producing a more specific forecast of EVs entering different market segments up to 2025 in order to acquire a better understanding of the whole scenario, as explained through figure 6.

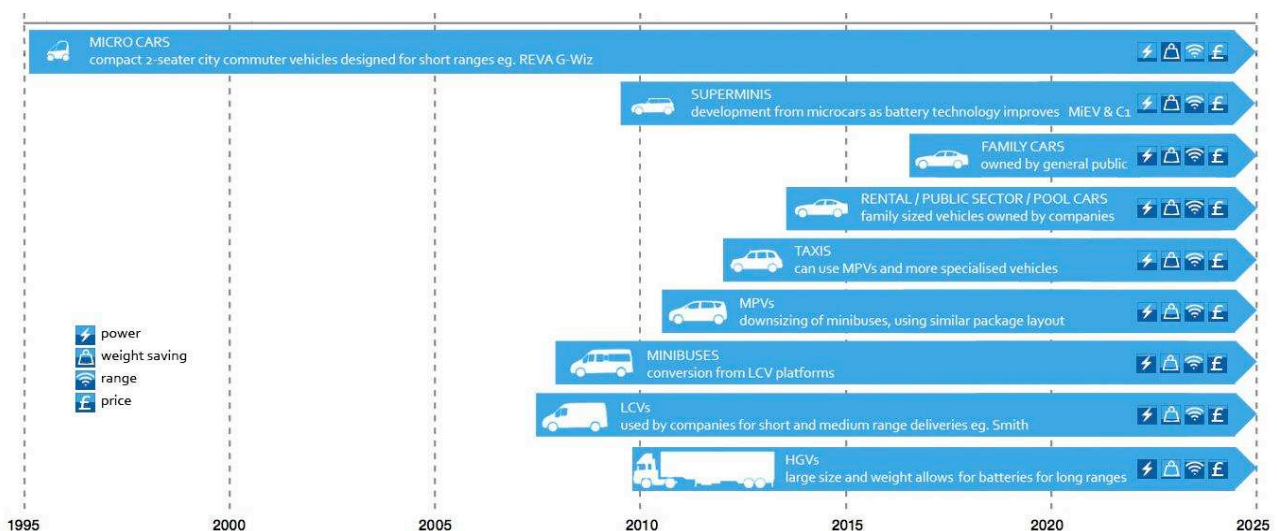

Figure 6 Projected scenario of electric vehicles entering different segments of the car market

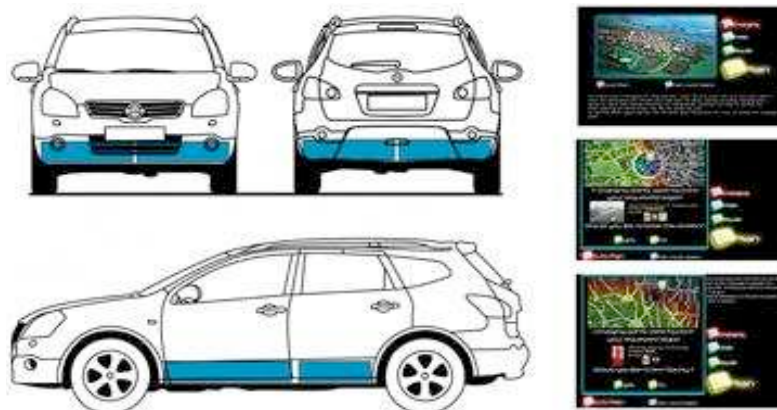

Figure 9 Multi battery concepts

Open Charging Zones (fig. 10)

The principle of Wi-Fi Open Zones is applied to the process of vehicle recharging to envisage possible concepts for new infrastructure. Charging zones for industrial and business use are considered along with possible billing systems and how home users might convert personal fast-charging stations for public use. Figure 10 demonstrates the concept through screen shots of a user-friendly interface.

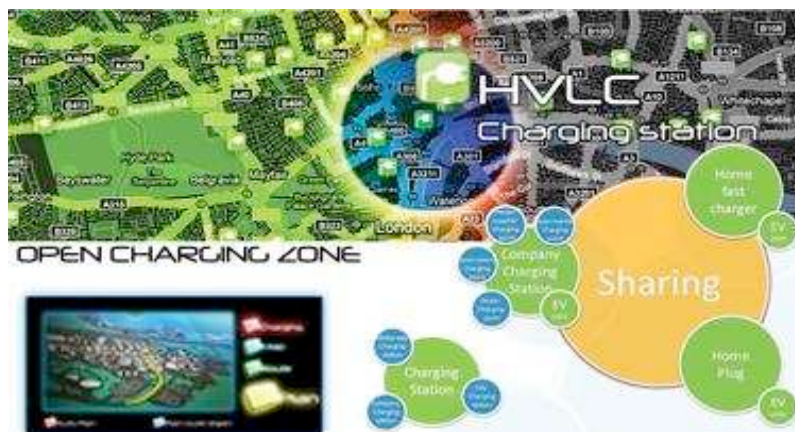

Figure 10 Open charging scheme

Wireless Charging (fig. 11 & 12)

Nothing would be as frustrating as forgetting to plug your electric vehicle in at night and returning the following morning to find a set of flat batteries. With an emphasis on user interaction on a day-to-day basis, these concepts aim to break free from a reliance on the cable and plug and offer potential static and in-motion charging solutions.



Figure 11 LCV Wireless charging

Motion Charging

Taking wireless charging a step further, as schematically illustrated in figure 12.



Figure 12 LCV Motion charging

Charging point intelligence (fig. 13)

Charging points allow for far greater functionality than just the flow of electricity to replenish the battery. Through the exploration of possible charging scenarios and locations we envisage two-way information transfer between charging point and vehicle. These concepts focus on the content of the data available and the ways in which companies could process it to offer added value to the user, as Figure 13 describes.

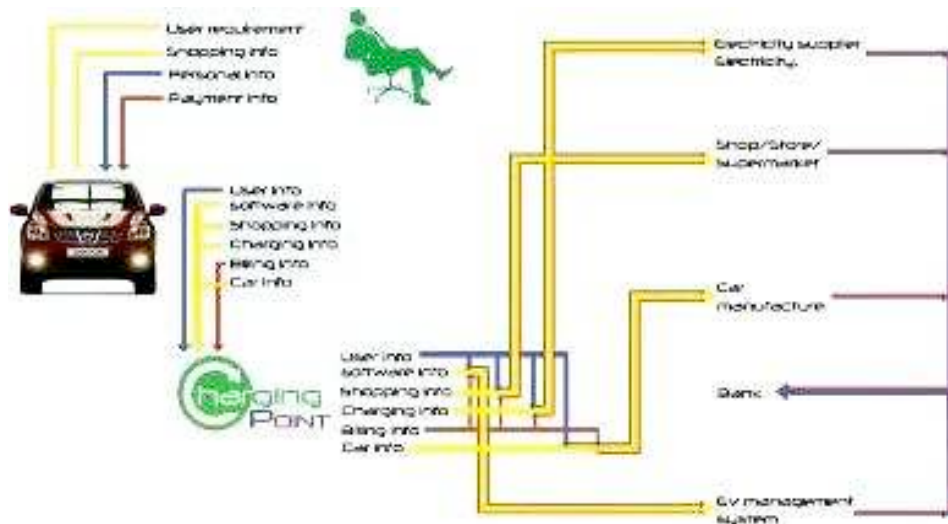

Figure 13 Charging point diagram

Electrolocation (fig. 14)

These concepts have been developed by studying the way that animals such as the platypus use electrolocation to build up a mental map of their immediate environment.



Figure 14 Vehicle's electrolocation

The application of printed electronics to body panels can provide relevant information about a vehicle's immediate vicinity, the driver can make more informed decisions and so drive with a greater degree of safety. By combining this technology with inter-car-communication, the driver can also be alerted to hazards by other road users.

Lighting (fig. 15)

Interior lighting can be developed to offer more than just good visibility. These concepts incorporate technology such as OLED lighting to enhance the experience of both driver and passengers.



Figure 15 OLED applied to vehicle windscreen

EV car rental (fig. 16)

Considering the price gap between comparative conventional engine vehicles and electric vehicles led the team to challenge the concept of vehicle ownership. Should the entire car (bodywork, engine and battery) or only certain parts be owned by the driver?

This group of concepts explores the implications of different states of ownership through the communication of car rental scenarios, these address issues of access, billing, security, duration of use, tracking, user interaction with the product and the service as a whole and integration with existing public transport systems. Figure 16 provides schematic explanation of such a scheme.



Figure 16 EV car rental scheme

Entertainment & sound systems (fig. 17)

By focusing on the user's experience of interacting with the vehicle, these concepts explore the integration of new and emerging technologies into the vehicle interior. The most notable are:

- The impact of the expansion of mobile wi-fi, enabling the vehicle user to access internet based services en-route.
- How the incorporation of printed electronics will lead to new and innovative application of lights, screens, touch-pads, sensors and solar cells.
- 'Audio partitioning' through the use of directional, flat-panel speakers that provide each user with an individual and customisable experience.



ENTERTAINMENT & SOUND SYSTEMS

Figure 17 On-board entertainment and sound systems

Commercial Applications (fig. 18)

These concepts use printed electronics in the form of printed organic light-emitting diodes (OLEDs) to vary vehicle graphics, branding and advertising displayed on the side of light commercial goods vehicles.



COMMERCIAL APPLICATIONS

Figure 18 Commercial vehicle featuring different advertising graphics

Conclusion

HVLC's strategic role and its relevance within the LCV field

Whilst political attention is focussed on finance, infrastructure and engineering, the LCV agenda lacks human centred design solutions that will embed low carbon vehicle technology into our society. Engineering R&D activities, while crucial, currently overshadow the potential offered by design to create the machine around the person. This presents us with the need to explore the functional, but foremost experiential user value that must be embodied in LCVs if they are to be considered viable and capable alternatives to petrol and diesel cars.

The HVLC team is concerned with the way users interact with products and systems, and the perceived worth given to this interaction. In addition, HVLC provides a strategic design approach that acts as a catalyst to juxtapose different technologies whilst retaining focus on the experience of the end-user. HVLC aims to seek further industrial partners in order to collaborate by offering transportation and industrial design expertise, as complementary disciplines, which are implemented across the main areas of engineering expertise provided by industry partners.

HVLC's Role as a LCV System Integrator

Ettlie (2006) iterated that the role of a new product strategy in the business unit has a significant impact on performance. This is particularly crucial in the development of LCVs as the auto industry spends 3 to 4 % of sales on R&D. It follows that the HVLC's mission is to assist the future LCV industry by driving innovative collaboration in regional industry as well as nationwide and overseas. This is accomplished by acting as a *System Integrator* for companies and emerging technologies as shown in figure 19.

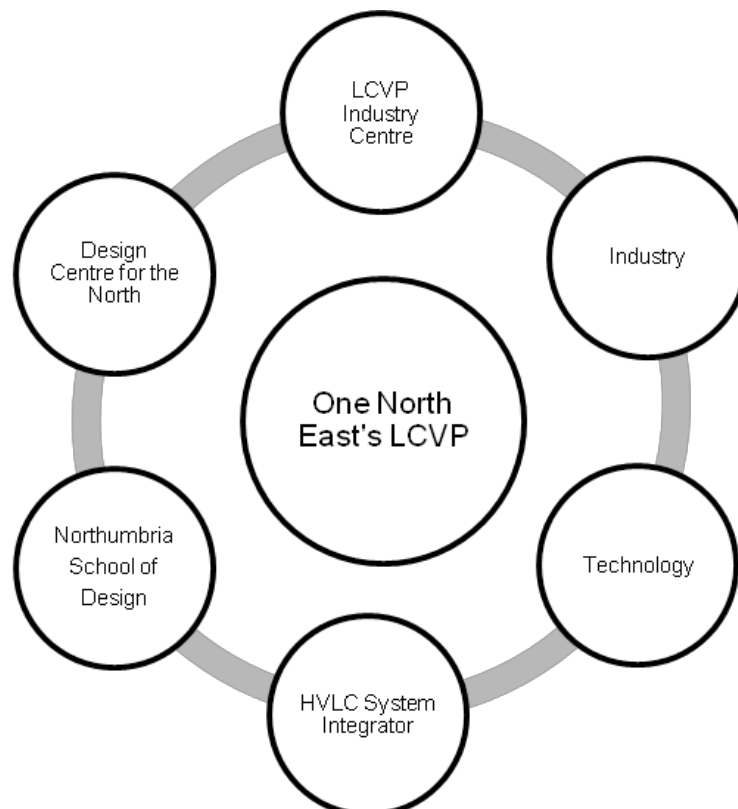

Figure 19 HVLC operating model

The researchers aim to develop HVLC as a creative *technical and design entity* offering value innovation management throughout design, engineering and marketing processes. Apart from the essential involvement of industrial partners HVLC aims to support all engineering and design R&D activities and overall carbon management of the manufacturing process with undergraduate placement students, post-graduate PhD and MPhil researchers to work on specific projects through the Knowledge Transfer Partnership (KTP) scheme and/or CASE Studentships.

To clarify the current nature of the LCV market Prof. Neville Jackson (Group Technology Director, Ricardo UK Ltd and Chairman, Low Carbon Vehicle Partnership) recently wrote that: 'Whilst the key market driver for lower carbon transport is regulatory, consumers have shown an increasing desire for the lower running costs and "greener" image of more fuel efficient vehicles. This has created a demand for new technologies and innovations that are both cost effective and, particularly for passenger cars, attractive, avoiding the perception that fuel efficient vehicles, by definition, are dull and boring. More fuel efficient combustion engines, vehicle innovations, electrification of drivetrains, including all electric and plug-in hybrid systems, are in development and will be introduced to the marketplace in a wide variety of combinations and products. These new technologies drive the demand for new supply chains, providing opportunities for new entrants to the automotive sector'.

References

- English, S.G. (2008) *Integrated mind mapping: multiple perspective problem framing*. Networks of Design. Proceedings of The Design History Society International conference Falmouth, UK 3-6 Sept ember, Universal Publishers, Florida (2009) pp, 35-41
- Ettlie, J. E. (2006) *Managing Innovation* (2nd ed.). Oxford: Butterworth-Heinemann
- Why is the car industry failing on climate change?* (n.d.). Retrieved January 9, 2010, from <http://www.stopurban4x4s.org.uk/leaflet.pdf>
- Pininfarina Bluecar*. (n.d.). Retrieved January 9, 2010, from <http://www.pininfarina.com/index/storiaModelli/Pininfarina-BlueCar.html>
- Hybrid And Pure Electric Cars 2009-2019*. (n.d.). Retrieved January 9, 2010, from http://www.idtechex.com/research/reports/hybrid_and_pure_electric_cars_2009_2019_000227.asp
- Rufford N., & Dawe J. (2008, March 08). Toyota Prius proves a gas guzzler in a race with the BMW 520d, *Times On Line*. Retrieved January 10, 2009, from http://www.timesonline.co.uk/tol/driving/used_car_reviews/article3552994.ece
- Srivastava M., (2009, August). Tata: Still Reeling from Its Jaguar-Land Rover Buy. *Bloomberg Businessweek*. Retrieved January 10, 2009, from http://www.businessweek.com/globalbiz/content/aug2009/gb20090811_307608.htm
- (July 2009) *The UK Low Carbon Industrial Strategy*. Retrieved January 10, 2009, from <http://www.berr.gov.uk/files/file52002.pdf>
- What is global warming? (n.d.) Retrieved January 10, 2010, from <http://www.climatecrisis.net/climate-change.php>
- World Development Report 2010 (n.d.) Retrieved January 10, 2010, from http://econ.worldbank.org/WBSITE/EXTERNAL/EXTDEC/EXTRESEARCH/EXTWDRS/EXTWDR2010/0,,menuPK:5287748~pagePK:64167702~piPK:64167676~theSitePK:5287741,00.html?cid=G_S_WDR2010EN_115
- Kyoto Protocol, (n.d.) Retrieved January 10, 2010, from http://unfccc.int/kyoto_protocol/items/2830.php
- CO2 and Cars, (n.d.) Retrieved January 10, 2010, from <http://www.ourclimate.eu/ourclimate/cocars.aspx>
- Rochat D. (n.d.) *The Bright Green Idea*. Retrieved January 10, 2010, from http://www.greenaer.ie/img/comparison_greenhouse_gas.gif&imgrefurl
<http://www.greenaer.ie/ecocredentials.php&usg=Pb6RXDaD2umAlxSFO2hHvBk9K8=&h=472&w=691&sz=12&hl=en&start=6&um=1&tbnid=itrdYFXN>
- (2008) The \$41 Billion Energy Storage Market: The Next Big Energy Investment, *Business Wire*. Retrieved January 10, 2009, from <http://www.pr-inside.com/the-41-billion-energy-storage-market-r614689.htm>
- (April 2009). *Ultra-Low Carbon Vehicles in the UK*. Retrieved January 10, 2009, from <http://www.berr.gov.uk/whatwedo/sectors/lowcarbon/vehicles/page50984.html>

Article in the online magazine or news

Wallis, C. (2005, January 09). The new science of happiness. *Time Magazine*. Retrieved July 15, 2006, from <http://www.time.com/time/magazine/article/0,9171,1015902,00.html>

Stand-alone Web document (no date)

Nielsen, M. E. (n.d.). *Notable people in psychology of religion*. Retrieved August 3, 2001, from <http://www.psywww.com/psyrelig/psyrelpr.htm>

Stand-alone Web document (no author, no date)

Gender and society. (n.d.). Retrieved December 3, 2001, from <http://www.trinity.edu/~mkearl/gender.html>.

Author Biography

Stuart English

Trained as an Industrial Designer, Stuart has worked in the field of Design Innovation for 20 years. He co-founded Glenelg Product Design in 1990 and at Northumbria University has championed design learning innovation whilst leading BA and MA courses in Design for Industry and professional design practice.

Stuart's research challenges the designer's capacity to be both innovative in terms of product designs and design processes. His approach confronts theory with practice and vice-versa. His practice has facilitated new product development through an inclusive approach based on design led entrepreneurship. This addresses multi and cross-disciplinary contexts bounded by clarity of market objectives, and has led to numerous filed patents.

Matteo Conti

Matteo has been a senior lecturer in Transportation Design and an industrial placement tutor for the past 9 years at Northumbria University. During this time he also led the course between 2005 and 2007 whilst retaining his core roles. This Italian bi-lingual academic has been creating various successful industrial partnerships with prestigious design consultancies (Pininfarina, Bertone, IdeA Institute, etc.) to carry out collaborative projects and secure students' placements. His mechanical engineering background led him to initially pursue a career as a robot programmer/engineer applied to vehicle manufacturing and painting.

His passion for design culminated in 1999 when he obtained a first class degree in BA (Hons) Transportation Design from Northumbria University. During his graduate work experience, at Alfa Romeo he was offered an enticing lecturer position at Northumbria which he could not refuse. In 2007 Matteo was appointed External Examiner at Domus Academy in Milan, for the MA course in Car Design. Through HVLC Matteo's intention is to develop further specific design and technical expertise in the EV field by undertaking major industrial R&D projects.