

Northumbria Research Link

Citation: Cheung, Wai Ming, Newnes, Linda, Mileham, Antony, Marsh, Robert and Lanham, John (2008) Through life costing in defence electronic systems: an integrated data-driven multi-level approach. In: Proceedings of the 38th International Conference in Computer and Industrial Engineering. Publishing House Electronics Industry, China, pp. 2119-2128. ISBN 978-71210074370

Published by: Publishing House Electronics Industry

URL:

This version was downloaded from Northumbria Research Link:
<http://nrl.northumbria.ac.uk/699/>

Northumbria University has developed Northumbria Research Link (NRL) to enable users to access the University's research output. Copyright © and moral rights for items on NRL are retained by the individual author(s) and/or other copyright owners. Single copies of full items can be reproduced, displayed or performed, and given to third parties in any format or medium for personal research or study, educational, or not-for-profit purposes without prior permission or charge, provided the authors, title and full bibliographic details are given, as well as a hyperlink and/or URL to the original metadata page. The content must not be changed in any way. Full items must not be sold commercially in any format or medium without formal permission of the copyright holder. The full policy is available online: <http://nrl.northumbria.ac.uk/policies.html>

This document may differ from the final, published version of the research and has been made available online in accordance with publisher policies. To read and/or cite from the published version of the research, please visit the publisher's website (a subscription may be required.)

www.northumbria.ac.uk/nrl



THROUGH LIFE COSTING IN ELECTRONIC DEFENCE SYSTEMS: AN INTEGRATED DATA-DRIVEN MULTI-LEVEL APPROACH

Wai Cheung

Department of Mechanical Engineering
University of Bath
UK
w.m.cheung@bath.ac.uk

Linda Newnes

Antony Mileham

Department of Mechanical Engineering
University of Bath
UK
{l.b.newnes, a.r.mileham}@bath.ac.uk

Robert Marsh

John Lanham

Faculty of Computing, Engineering and
Mathematical Sciences
University of the West of England
UK
{r.marsh, j.d.lanham}@uwe.ac.uk

ABSTRACT

Cost estimating is a business process that is critical to the defence sector, where many products have low volumes and long life cycles. The nature of a defence system is often unique (for example, a naval platform) which consists of a number of sub-systems and components. For the design of such a system cost estimating is a critical task, in particular the requirement to predict the cost throughout the system's lifetime. The aim of this paper therefore is to discuss an integrated approach that provides a general framework for through life costing in defence systems via the development of: (1) a generic data library to support designers and cost estimators, (2) data searching and transfer mechanisms to support a top-down and bottom-up hybrid cost modelling approach, (3) capturing reliability data to support product services. The paper is divided into several sections, first, a review of relevant research projects concerning integration and data capture for cost modelling. This is followed by a section, which highlights problems of performing cost estimates for low volume products, and subsequently the proposed solution, methods of cost estimation and example applications. Perhaps most importantly, the methods created in this research are able to enhance decision-making and accelerate the responsiveness of the business bidding process.

KEYWORDS

Cost Estimating, Through Life Costing, Defence Systems, Data-driven, Integrated Cost Modelling

1. INTRODUCTION

The achievement of the Japanese manufacturing techniques such as 'lean' and 'just-in-time' to reduce product development cycle time inspired the development of 'concurrent engineering' (CE) in the late 1980s. With the success of CE and the need of product development collaboration and distribution, a buzzword emerged and this was termed 'integration' (Cheung, W.M., et al., 2007a), (Gao, J.X., et al., 2003). Integration has been a subject of numerous research efforts since the late 1990s. However, in product development, integration techniques were predominantly applied to the development of enterprise systems such as Product Lifecycle Management and Enterprise Resource Planning systems to address linking Computer-Aided Design (CAD), Computer-Aided Manufacturing and the business process. Until recently, there is very little evidence of integration as a technique being applied in cost estimation.

In industry, cost estimation is an important procedure to be used to measure the feasibility of a product as well as to predict the success or failure of a product.

In order to measure the cost of making a product, there are different costing methods and techniques available. Traditional costing methods and techniques are usually performed using historical data and knowledge (Niazi, A., et al., 2006) and (Layer, A., et al., 2002). Whether it is in the design, the manufacturing or other stages of a product's development, cost estimation depends on availability of data and knowledge.

Nowadays, companies are more concerned to prepare lifecycle cost estimates of a product from its conception until the end of its life. In the recent past, there have been a number of research projects undertaken to address various issues in life cycle costing (Cheung, W.M et al., 2007b). However, methods have been deployed to predict lifecycle costs only after a product model has been built, and not at an early design stage when there is little data and information available. Furthermore, the cost models and systems used required a large amount of detailed data before a cost calculation could be made. One of the objectives in this paper is to discuss the development of an integrated approach of Through Life Costing (TLC) for low volume defence electronic systems. From the Ministry of Defence in the UK (ISO/DIS 15685-5), TLC is defined as a technique to establish total cost of ownership that consists of capital costs, operating costs (e.g. Staffing, Energy Consumption, Maintenance and associated consumables) and Disposal costs (including residual value).

The layout of this paper is as follows: Section 2 describes the relevant research in using integration and data capture approaches in cost modelling. Section 3 highlights the problems of performing cost estimates for low-volume product. Section 4, 5 and 6 discuss the proposed solutions, the methods and example applications. Finally, the conclusion and future work is presented.

2. RELATED RESEARCH

Integration as a subject of research in product development was introduced in the late 1990s. Research in cost modelling using an integrated approach, however, is limited. Among the authors, Roy, R. et al., (2008) presented a function-based cost estimating framework to link commercial and engineering cost estimation activities through a structured approach at the conceptual design stage. The cost estimation process at the commercial level uses the functional requirements of a design, where

the engineering level is based on the data from previous products. The approach proposed the integration of the two activities to improve the communication of cost estimation processes on an automotive exhaust system. Curran, R., et al., (2007) presented a methodology to facilitate cost modelling with the integration of design and manufacturing at the concept design stage. The methodology was to exploit manufacturing simulation capabilities associated with digital mock-up data to obtain real-time cost estimates for a fuselage of a commercial jet. The objective was to reduce life cycle cost (LCC) in the design process. Earlier research by Curran, R., et al., (2005) was the application of the Genetic-Causal principle and integration of this into the conceptual design stage for aircraft cost modelling. The aim of Curran's research was to seek an understanding of the impact of life cycle cost when linking customer requirements with conceptual design parameters.

Scanlan, J., et al., (2006) launched a project called DATUM with Rolls-Royce PLC to establish a prototype system for the creation of a cost model structure to integrate with a design optimisation system. The aim of the research was to practically instantiate earlier research that bridged the cost estimation process between the parametric and generative techniques to better support design decision-making. Similarly, Seo, K.K., et al., (2002) described the development of an LCC estimation method called a learning LCC model for use at the conceptual design stage. The method facilitates an integrated view of the design process for the rapid estimation of product LCC based on high-level information during the conceptual design phase. Since "Learning LCC Models" are based on neural network algorithms trained to use the known characteristics of existing products, again, this method cannot be applied in the LCC estimation of low volume products.

Additionally, the above research projects did not address the importance of using data in cost estimation. As pointed out by Baguley, P. et al., (2004), a key part of cost modelling is in identifying and collecting relevant data from data sources. A typical example is research carried out by Emsley, M.W., et al., (2002) which introduced a data modelling approach, however, the research relied on previous project data and the application of neural networks for the prediction of total construction costs. This is not applicable in terms of low volume products. Another piece of research by El-Haram,

M.A., et al., (2002) proposed the development of a framework for capturing 'whole life cost' data for a construction project. They proposed that the first step of whole life costing (WLC) was to create or adopt a cost breakdown structure that identified all relevant cost categories in all appropriate life cycle phases. The proposed WLC breakdown data structure was divided into five levels: (1) Project Level, (2) Phase Level, (3) Category Level, (4) Element Level and (5) Task Level. In the centre of the cost breakdown structure there was a pool of data and information. Based upon these conditions, they developed a WLC breakdown data structure that was then computed as a system dictionary in which all data was listed and defined. As this framework was developed for the construction sector, it may not be applicable in electronics defence products. In summary, the research projects reviewed so far do not apply to defence systems in particular from a point of view of low volume products.

3. INDUSTRIAL PROBLEMS OF THROUGH LIFE COSTING IN LOW VOLUME DEFENCE ELECTRONIC SYSTEMS

The key industrial problems to perform cost estimating for low volume long life products are: (1) lack of historical data and knowledge, and (2) insufficient statistically significant data, during the early stages of product design (Newnes, L.B. et al., 2006). For the design of such products, cost estimation is a critical task, in particular the requirement to predict the cost throughout the product lifetime. A typical example is a naval platform defence system, where further problems can be added due to the nature of this type of product, which usually consists of a number of sub-systems and components (Hedvall, M., 2004). For instance, the interdependences between various sub-systems might create additional costs and differences in life span and upgrade characteristics are usually difficult to predict and manage.

In this situation conventional approaches in cost estimation methods are often quite unreliable as rarely are there similar cases that can be used as a basis for estimating future systems. As reported by both Ullman, D.G., (2002) and Kawauchi, Y., et al., (2002) when the design of a product is complete, although only 20% to 30% of the total cost has been spent, 70% of the costs will have been committed, and the more the project is advanced the greater the

difficulty of reducing the final cost because of the high costs of modification and change. It is thus essential to understand the value of design parameters as early as possible in the design cycle and preferably at the conceptual design stage.

The hypothesis of this research is shown in Figure. 1. When an order for a low volume, long life defence system is received from a customer, rapid feedback of the relevant quotations should be presented in the negotiation process. The methods to achieve this requirement are as follows: (1) a digital data library to allow agile product configuration, (2) common data format to represent data and information of costing analysis; and (3) facilities to support and predict TLC from the initial concept stage of a design until the end-of-life of a product. The potential industrial benefits will be the demonstration of increased front-end responsiveness and improved decision making of a design, thus enhancing the opportunity of winning business contracts by tendering the appropriate bids.

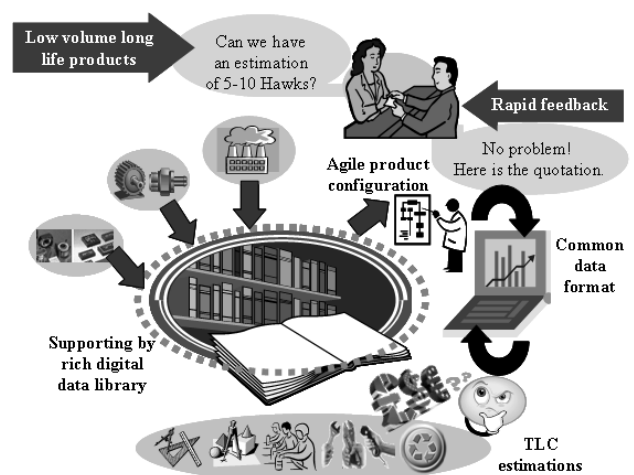

Figure 1 Research hypothesis of Through Life Costing for Low Volume Long Life Products

4. THE PROPOSED SOLUTION FOR THROUGH LIFE COSTING IN DEFENCE ELECTRONIC SYSTEMS

One of the objectives in this paper is to discuss the development of an integrated cost modelling approach. The approach is focused on the solutions that will support TLC of low volume defence electronic systems. These will meet the following criteria:

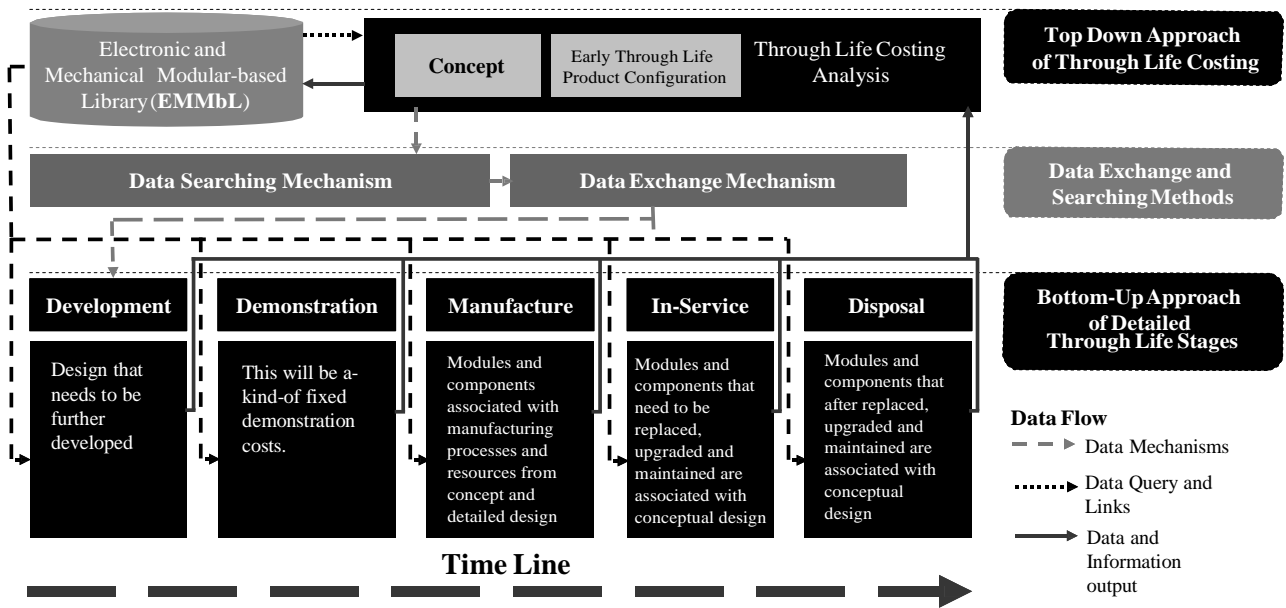

Figure 2 Integrated Data-driven Multi-level Through Life Costing Architecture (IDMTLC)

- To develop and evaluate a methodology that provides a general framework for through-life cost estimation.
- To provide a hybrid bottom-up, top-down approach (Pugh, P.G., 2004) to cost estimating for defence systems, in order to support a rough-cut cost estimate based on low detail at the concept design stage of product design
- To accept greater detail to improve the accuracy of the cost estimate, progressively through the design and realisation process and during the phases of in-service and disposal.

The proposed integrated cost modelling approach is illustrated in Figure 2. The overall integration environment is categorised into three levels. The first level is a top-down approach, which consists of a generic data library to support designers and cost estimators in particularly during the early stage of design concept configuration. The second level is the data mechanism level, which consists of ‘data searching’ and ‘data exchange’ abilities. The third level is used to support a bottom-up approach of development, demonstration, manufacture, in-service and disposal stages of a product’s lifecycle.

The novelty of the work is: (1) to create a generic data library to support agile product configurations

which requires as little information as possible from the users at the top-down stage, (2) the development of a data searching mechanism to support cost estimating accuracy and a data transfer method to support the hybrid approach, (3) to capture reliability data to address maintenance, replacement, upgrade and disposal issues right from the design concept stage.

5. IMPLEMENTATION OF THE INTEGRATED COST MODELLING APPROACH

5.1. The TLC Architecture and Software Applications

The architecture for implementing the IDMTLC is shown in Figure 3. A general purpose modelling tool Vanguard Studio (Vanguard Software, 2008) is used at the ‘top-down’ level. The top-down approach is used to enable one form of elaboration of an abstract design to perform cost estimating at the early design process where availability of historical and statistically significant data is limited. Furthermore, a typical defence system usually consists of a number of sub-systems and components. Due to this nature of system configuration, a modular technique is used to support the top-down approach. The reason for using Vanguard Studio is because it has a graphical, modular and object-oriented capability to ease the development process and the objects created can

exchange information with the common format, 'spreadsheets'.

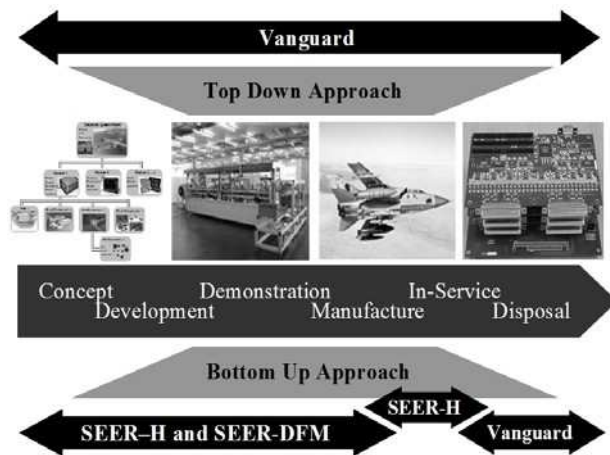

Figure 3 Software applications for the IDMTLC

For the 'bottom up' level, the architecture used is a combination of SEER-H, SEER-DFM (SEER, 2008) and Vanguard Studio. The bottom-up approach utilises existing historical data and information where possible, for example, existing models and old products. The reason for using SEER is because of its existing electronic knowledge-based library and user input knowledge base. It allows users to create a modular-based design approach. SEER also allows users to input attributes such as dimensions, weight, material etc for a detail design level estimate. Both SEER-H and Vanguard Studio will also be used to capture in-service data to determine in-service and disposal costs.

The final and perhaps the most important reason is the fact that Vanguard and SEER have the capability to share parametric and generative costing data with SEER being used in its "server mode". Each tool is capable of being used to model the TLC, and each has particular advantages over the other. Currently the architecture takes advantage of the features of all packages that are being integrated.

5.2. Method of Creating the Digital Library

At the top-down level, an "Electronics and Mechanical Modular-based Library (EMMbL) has been developed. Figure 4 illustrates the steps of developing the EMMbL. The initial process was to use the Unified Modelling Language (UML) (Blaha, M.R., et al., 2004) to define an abstract representation of the EMMbL. The second step was

to create a main directory for the EMMbL and was followed by defining the subdirectories as shown in Step 3. The resulting cost elements were established in Step 4 which is explained in the following paragraph.

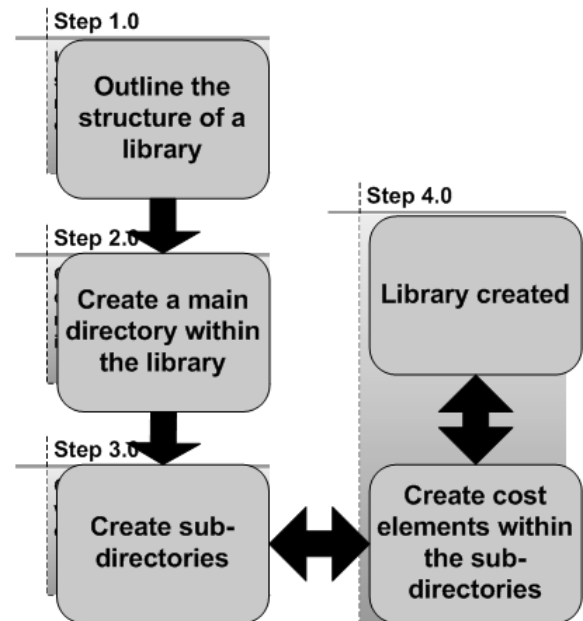

Figure 4 Steps of creating the EMMbL

The EMMbL is a data structure to be used to capture cost data and information of a group of specific domains as illustrated in Figure 5. Each of the domains is categorized into electronics, mechanical modules/components, product, process and resource. The final step is to populate cost data within a subdirectory. An example is shown in Figure 6, a video_unit in the 'videos' of the 'Electronic Modules' subdirectory. The EMMbL also has included in it two further modules, namely process and resource. The process module consists of a set of pre-stored cost datasets on assembly, machining and surface mount technology processes. The resource module contains the cost information of factories, machines and tooling data, which is directly linked to the performance of processes.

Overall, the EMMbL enables designers to configure a product from existing modules. These modules will allow users to define the relationships with the components from the EMMbL. The library should allow designers and cost estimators to perform rapid configurations of a product once the requirements have been received from a customer.

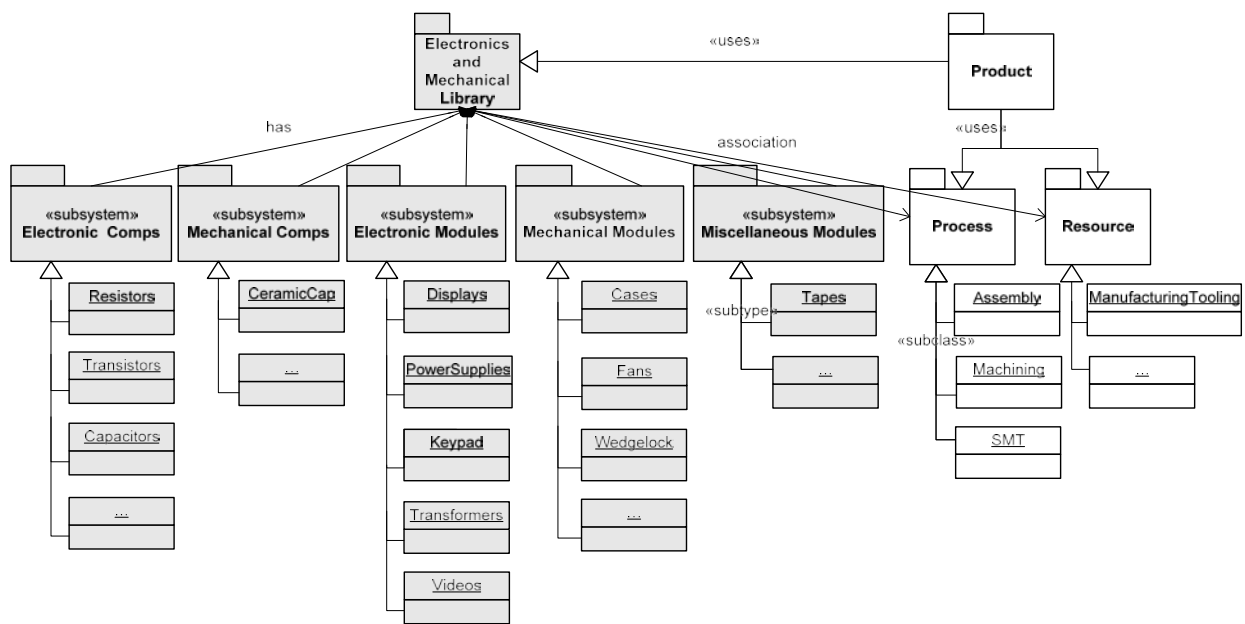

Figure 5 UML representation of the EMMbL

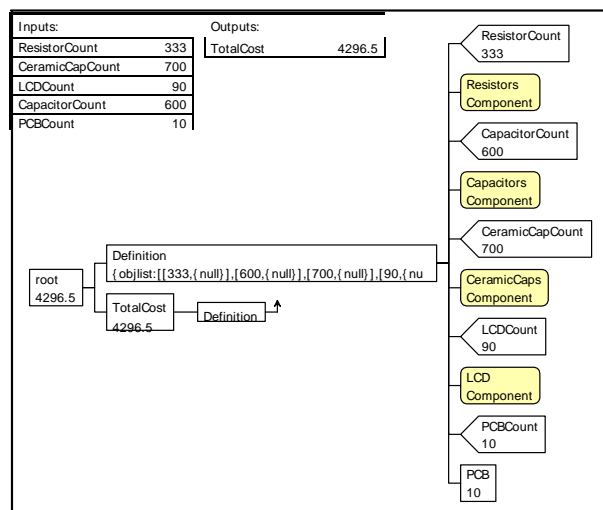

Figure 6 Example cost data

5.3. Methods of Capturing Reliability and Upgrade Data

It has been envisaged that ‘reliability’ and ‘upgrade’ data from Original Equipment Manufacturers can be used to support the ‘in-service’ and ‘disposal’ stages of the TLC. The in-service is a stage that can be used to predict costs of ‘upgrade’, ‘maintenance’ and ‘replacement’. The disposal stage is used to calculate potential costs that may occur when a module, part or component reaches the end-of-life. Several

implementation methods have been proposed to address the reliability issues in the IDMTLC:

- 1- Upgrade data of Commercial-Off-The-Shelf (COTS) products from the suppliers. In many cases, COTS produced by manufacturers should have a characteristic to indicate when that particular part should be obsolete and when it would be upgraded. An example is shown in Figure 7.

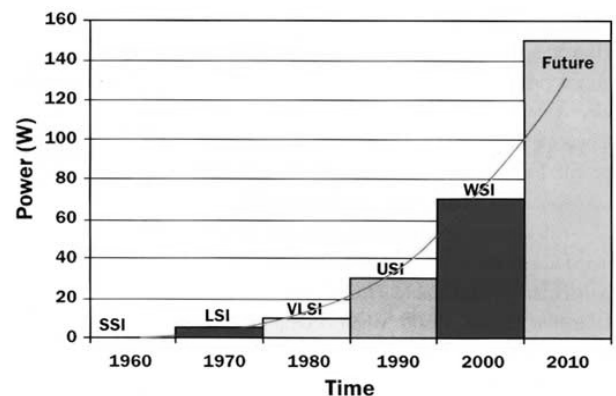

Figure 7 Evolutions of VLSI (courtesy of National Instruments Corporation)

- 2- Capturing reliability data using ‘Test and Field Data Based Predictions’ techniques (Fuqua, 2005). Table 1 summarizes the data needed for reliability analyses. The failure rate of the hardware (including modules or

components) can be determined from the following equation:

$$FailureRate = \frac{NumberOfFailures}{OperatingTime} \quad (1)$$

Information Required	Product Field Data	Product Test Data
Data collection time period	√	√
Number of operating hours per product	√	√
Total number of observed maintenance actions	√	
Number of 'no defect found' maintenance actions	√	
Number of induced maintenance actions	√	
Number of 'hard failure' maintenance	√	
Number of observed failures		√
Number of relevant failures		√
Number of non-relevant failures		√

Table 1 Use of existing reliability data (Fuqua, N.B., 2005)

- 3- Mean Time Between Failures (MTBF) is a common reliability measure used to assess the failure behaviour of repairable systems (Amari, 2006). Therefore, the life expectancy in electronic hardware and mechanical products can be predicted and represented by MTBF. Thus, this research has adopted the following expression to calculate the life expectancy of electronic and mechanical modules used in the EMMbL.

$$MTBF = \frac{\sum (Downtime - Uptime)}{NumberOfFailures} \quad (2)$$

- 4- The final type of reliability data is 'Part Count Prediction (PCP)' (Fuqua, N.B., 2005). However, PCP relies on historical data of electronic components. PCP is used to analyze electronic circuits in the early design phase, which can also be applied to the later stages of design and development. The method starts with the listing of part type and quantities. Reliability data is then taken from source books and software programs such as (IEC-62380, 2004) and (SR-332, 2005). Failure rates, quantities and parts are multiplied and the results for each part type are summed to determine the

product reliability. The general expression for a product failure rate using this method is given by Fuqua (2005):

$$\lambda_{product} = \sum_{i=1}^n N_i (\lambda_G \Pi_{A_i}) \quad (3)$$

Where:

- $\lambda_{product}$ = total failure rate
- λ_{G_i} = Generic failure rate for the i generic part
- Π_{A_i} = Adjustment factor for the i generic part
- N_i = Quantity of i generic part
- n = Number of different generic part categories

Based on the above mathematical derivatives, the following abstract expressions have been defined for calculating costs at the in-service stage:

$$replacementCostOfSingleModule/Component = (MeanSingleFailureCost * FailureRate * MTBF) \quad (4)$$

$$replacementCostOfSingleProduct = (MeanSingleFailureCost * \lambda_{product} * MTBF) \quad (5)$$

$$maintenanceCost = (replacementChargeRate * MeanDownTime) \quad (6)$$

All the data required for the above methods can be stored into the EMMbL and supported by the capabilities of SEER-H and Vanguard Studio.

5.4. Methods of Creating the Data Searching and Exchange Mechanisms

5.4.1 Data Searching Mechanism

A Data Searching Mechanism (DSM) is currently under development in an open source framework called jCOLIBRI CBR (jCOLIBRI, 2008). The DSM will be used to search for relevant cost information during the design configuration process at the concept stage. It is at this stage that the cost of alternative design concepts need to be determined and as precisely as possible.

In this research, six types of data sets have been identified. The rules used in the DSM are based on the data sets. These are:

- 1- Parametric - Physical characteristics or parameters such as weight, volume, length and the number of input/output to form a Cost Estimation Relationship.

- 2- Detailed - When parametric data is unavailable but a number of sub-systems existed for further cost analysis.
- 3- Bill-of-Materials (BoM) - a BoM is available of the selected design, thus historical data is available.
- 4- Fixed Cost - COTS products.
- 5- External Model - Explicit and implicit knowledge.
- 6- Variant - Based on existing products that are composed of existing basic components rather than newly designed. Thus, variant design uses a 'product family' approach.

The data sets contain different types of cost information, which are mapped and associated with the EMMbL modules and components. Several Artificial Intelligent techniques have been tested to implement the DSM, these are rule-based, case-based, Bayesian Net, and Decision Tree (Turban, E., et al, 2004); (Williamson, J., 2004). The case-based reasoning technique has been chosen to develop the DSM in this research. The reasons for this choice are tabulated in Table 2, and are due to the fact that case-based reasoning has advantages of ease of used and maintenance, and most importantly it can be used to seek out best practice solutions to existing problems and adapt them to solve new and similar problems.

	Characteristics of reasoning system for choice of model		
	Ease of Use	Uncertainty	Ease of Maintenance
Rule-Based	H	L	L
Case-Based	H	L	H
Bayesian	M	H	M-L
Decision-Tree	H	L	H

High (H) Medium (M) Low (L)

Table 2 Comparison of reasoning systems

5.4.2 Linking and Mapping Methods for Data Exchange Mechanism

In order to share parametric and generative data in server mode, a linking method has been developed in 'Excel Macro' in order to share spreadsheet information from bottom-up to top-down stages or vice versa. The Macro method is written in Visual Basic and can pass parameters to cost models. The mapping method utilises dynamic data exchange (DDE) (Shepperson, K., et al, 2008) at the top-down

stage to share data with the concept and detailed stages.

Detailed cost modules will be created within SEER-H, because detailed cost estimation is dependent on component dimensions, weight etc. Modelling of product 'demonstration' cost and the costs associated with 'manufacture' will be developed within SEER-DFM. Modelling of 'in-service' and 'disposal' stages will be mixed between SEER-H and Vanguard.

6. THE IDMTLC APPLICATION ENVIRONMENT

Figure 8 depicts an example of the application of using the IDMTLC architecture in through life costing. The first step is to perform a product configuration (1) by selecting the most appropriate modules to meet the conceptual requirements. The selection of the appropriate modules is based on the input and output of each module selected from the EMMbL. For example, if a display unit requires a maximum power of 50 Watts, then a power supply of that power rating must be used. Once the right modules have been put in-place, the next stage is (2) to use the 'data searching mechanism' to search the relevant cost information and data to enable a suitable cost estimation to be performed. If a detailed design or modification is required for a specific module, this will then be transferred to the development stage (3). The EMMbL has been

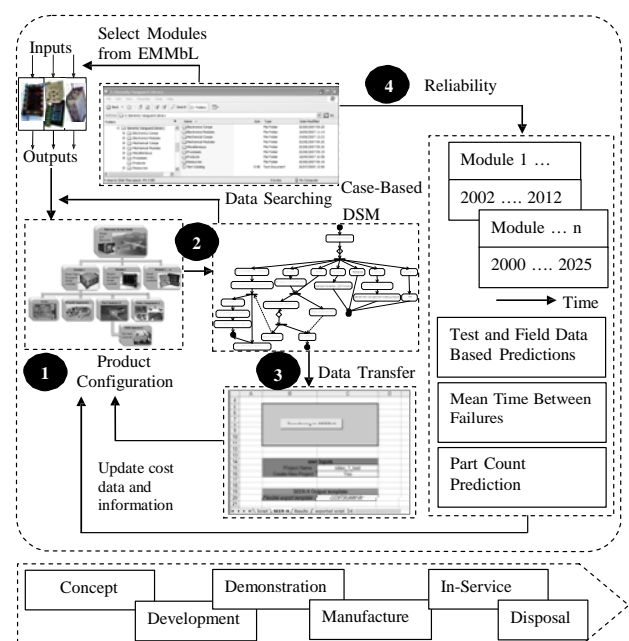

Figure 8 Functional relationship block diagram

developed with the most up-to-date cost information, and thus total design costs at the concept and development stages can be determined. After a design has been specified and a series of processes and resources in relation to the design have been defined, the associated manufacturing cost can also be determined.

As described in Section 5.3, cost estimation of the 'in-service and disposal' stages is supported by reliability and upgrade data. Thus, once the design of a product and manufacturing design have been finalised, the 'in-service and disposal' stages (4) can be carried out. The 'in-service' evaluation process is based on the selected modules and components. In the process, 'when' and 'which' specific module and component need to be replaced, upgraded and maintained can be identified from the timelines and failure rates. The subsequent 'disposal' costs can also be calculated based on the weight of material recovered, transportation and landfill requirements for example.

7. CONCLUSIONS AND FURTHER WORK

This paper has presented and discussed the development of an integrated cost modelling approach. The methods used to create the integrated environment have been developed. Methods of capture and storage of reliability data have been defined. Further work is to include the identification of how the reliability methods and associated cost models can be implemented. The overall contributions of this work are the IDMTLC approach and its methods that allow agile product configurations and rapid decision making to accelerate responsiveness in a business bidding process of low volume long life defence systems.

ACKNOWLEDGMENTS

The authors would like to thank the following for assisting their research activities in this area: In particular the industrial collaborators, MOD DE&S Supplier Engagement Team - Terry Johns and GE-Aviation. The EPSRC, the Innovative electronics Manufacturing Research Centre (IeMRC) (GR/T07459/01) and the University of Bath's Innovative design and Manufacturing Research Centre (IdMRC) for funding the research, and finally Andy Langridge and Keith Garland from Galorath International Ltd, Dr Brian Lewis from Vanguard Software Corporation. This paper is presented as part

of the joint research being undertaken by the Universities of Bath and the West of England on the investigation of "Cost Estimating for Low Volume Long Life Products in Electronic Defence Systems".

REFERENCES

- Amari, S.V., (2006), "Bounds on MTBF of Systems Subjected to Periodic Maintenance", IEEE Transactions on Reliability, Vol.55, No.3, pp.469-474.
- Baguley, P., Schaefer, D. and Page, T., (2004), "Costing Issues Regarding Product Variant Design", Proceedings of the 1st International Conference on Electrical/Electromechanical Computer-Aided Design & Engineering, ECAD/ECAE 2004, University of Durham, UK, pp. 41-45, ISBN 0-9535558-3-6.
- Blaha, M.R., and Rumbaugh, J.R., (2004), Object-oriented Modelling and Design with UML, Publisher: Prentice Hall; 2ND Edition, ISBN-10: 0130159204, ISBN-13: 978-0130159205.
- Cheung, W.M., Matthews, P.C., Gao, J.X. and Maropoulos, P.G., (2007a) "Advanced Product Development Integration Architecture: an Out-of-Box Solution to Support Distributed Production Networks", International Journal of Production Research, Vol.46, No.12, pp.3185-3206.
- Cheung, W.M., Newnes, L.B., Mileham, A.R., Marsh, R. and Lanham, J.D., (2007b), "A Study of Life Cycle Costing in the Perspectives of Research and Commercial Applications in the 21st Century", Proceedings of the ASME International Design Engineering Technical Conferences & Computers and Information in Engineering Conference, IDETC/CIE 2007, Las Vegas, Nevada, USA, DETC2007-34425.
- Curran, R., Gomisa, G., Castagne, S., Butterfield, J., Edgar, T., Higgins, C. and McKeever, C., (2007), "Integrated Digital Design for Manufacture for Reduced Life Cycle Cost", International Journal of Production Economics, Vol.109, pp.27-40.
- Curran, R., Price, M., Raghunathan, S., Benard, E., Crosby, S., Castagne, S., Mawhinney, P., (2005), "Integrating Aircraft Cost Modelling into Conceptual Design", Journal of Concurrent Engineering: Research and Applications, Vol.13, No.4, pp.321-330.
- El-Haram, M.A, Marenjak S., Horner R.M.W., (2002), "Development of a Generic Framework for Collecting Whole Life Cost Data for the Building Industry", Journal of Quality in Maintenance Engineering, Vol.8, No.2, pp.144-15.
- Emsley, M.W., Lowe, D.J., Duff, A.R., Harding, A. and Hickson A, (2002), "Data Modelling and the Application of a Neural Network Approach to the Prediction of Total Construction Costs", Construction Management and Economics, Vol. 20, pp. 465-472.

- Fuqua, N.B, (2005), "Electronic Reliability Prediction", Selected Topics in Assurance Related Technologies - Reliability Analysis Centre, Vol.4, No.2.
- Gao, J.X., Aziz, H., Maropoulos, P.G., Cheung, W.M., (2003), "Application of Product Data Management Technologies for Enterprise Integration", International Journal of Computer Integrated Manufacturing, Vol. 16, No. 7/8, pp. 491-500.
- Hedvall, M, (2004), "Change as a Cost Driver in Defence Procurement", Defence and Peace Economics, Vol.15, No.1, pp.101-108.
- IEC-62380, (2004), Reliability Data Handbook - A Universal Model for Reliability Prediction of Electronic Components, PCBs and Equipment, American National Standards Institute, TR Edition 1.0.
- ISO/DIS 15685-5, (2003), Building and Constructed Assets - Service Life Planning Part 5; Whole Life Costing.
- jCOLIBRI, (2008), An Open Source Case Base Reasoning Framework, <http://gaia.fdi.ucm.es/grupo/projects/jcolibri/>
- Kawauchi, Y. and Rausand, M, (2002), "A New Approach to Production Regularity Assessment in the Oil and Chemical Industries", Reliability Engineering and System Safety, Vol.75, pp.379-388.
- Layer, A., Ten-Brinke, E., Houten, F.V., Kals, H. and Haasis, S., (2002), "Recent and Future Trends in Cost Estimation", International Journal of Computer Integrated Manufacturing, Vol.15, No.6, pp.499-510.
- Newnes, L.B. and Mileham, A.R., (2006), "A Proposed Method for Cost estimating for Low Volume Infrequent Electronic Products", Proceedings of the 13th International Conference on Concurrent Engineering (ISPE CE 2006), Antibes, France, IOS Press, ISBN 1-58603-651-3, pp. 699-706.
- Niazi, A., Dai, J.S., Balabani, S. and Seneviratne, L., (2006), "Product Cost Estimation: Technique Classification and Methodology Review", Journal of Manufacturing Science and Engineering, No.128, pp.565-575.
- Pugh, P.G., (2004), "Concept Costing for Defence Projects: the Problem and its Solution", Defence and Peace Economics, Vol.15, No.1, pp.39-57.
- Roy, R., Souchoroukov, P. and Griggs, T., (2008), "Function-based Cost Estimating", International Journal of Production Research, Vol.46, No.10, pp.2621-2650.
- Scanlan, J., Rao, A., Bru, C., Hale, P. and Marsh, R., (2006), "DATUM Project: Cost Estimating Environment for Support of Aerospace Design Decision Making", Journal of Aircraft, Vol.43, No.4, pp.1022-1028.
- SEER, (2008), <http://www.galorath.com/>
- Seo, K.K., Park, J.H., Jang, D.S. and Wallace, D., (2002), "Approximate Estimation of the Product Life Cycle Cost using Artificial Neural Networks in Conceptual Design", International Journal of Advanced Manufacturing Technology, Vol.19, pp.461-471.
- Shepperson, K., Barbara, K., Khambhati, S. and Palanca, R., (2008), "Using Dynamic Data Exchange (DDE) and Macro Variables to Create Custom Excel Workbooks with Multi-Sheets", Proceedings of the SAS Global Forum 2008 Conference, San Antonio, Texas, Paper 229.
- SR-332, (2005), "Reliability Prediction Procedure for Electronic Equipment", Telcordia Technologies, Issue 2.0.
- Turban, E., Aronson, J.E., and Liang, T.P., (2004), Decision Support Systems and Intelligent Systems, Publisher: Prentice-Hall, Inc, 7th Edition, ISBN: 0130461067.
- Ullman, D. G., (2002), The Mechanical Design Process, Publisher: McGraw-Hill Higher Education; 3rd Edition, 416 pages, ISBN-10: 0071122818 ISBN-13: 978-0071122818.
- Vanguard software, (2008), <http://www.vanguardsw.com/>
- Williamson, J., (2004), Bayesian Nets and Causality: Philosophical and Computational Foundations, Publisher: Oxford University Press, ISBN-10: 019853079X, ISBN-13: 978-0198530794.