

Reconfigurable Mechanism Generated from the Network of Bennett Linkages

Chao-Yang Song², Huijuan Feng¹, Yan Chen^{1*}, I-Ming Chen², Rongjie Kang¹

¹Key Laboratory of Mechanism Theory and Equipment Design of Ministry of Education, Tianjin University, Tianjin, 300072, China

²School of Mechanical and Aerospace Engineering, Nanyang Technological University, 50 Nanyang Avenue, Singapore 639798

ABSTRACT

A network of four Bennett linkages is proposed in this paper. Totally five types of overconstrained $5R$ and $6R$ linkages, including the generalized Goldberg $5R$ linkage, generalized variant of the L -shape Goldberg $6R$ linkage, Waldron's hybrid $6R$ linkage, isomerized case of the generalized L -shape Goldberg $6R$ linkage and generalized Wohlhart's double-Goldberg $6R$ linkage, can be constructed by modifying this Bennett network. The $8R$ linkage formed by Bennett network serves as the basic mechanism to realise the reconfiguration among five types of overconstrained linkages by rigidifying some of the joints. The work also reveals the in-depth relationship among the Bennett-based linkages, which provides a substantial advancement in the design of reconfigurable mechanisms using overconstrained linkages.

KEYWORDS

Reconfiguration, overconstrained linkage, Bennett-based linkage

* Corresponding author, email: yan_chen@tju.edu.cn

1 Introduction

Reconfigurable mechanism involves the design philosophy of fulfilling multiple tasks in different configurations using one comprehensive mechanism or integrated system. A recent review by Kuo, Dai and Yan [1] summarized the principals to change the topologies and/or configurations of mechanisms, including the number of effective links and/or joints, the kinematic pairs on certain joints, the adjacency and incidence of certain links and/or joints and the relative topology between links and/or joints. These principals could be separately applied or comprehensively hybridized to form different strategies for reconfigurable mechanism design. Based on robotic automation and systematic integration, several reconfigurable robotic platforms have been developed on the re-assembly of identical or similar robotic modules [2-4]. Some modular reconfigurable robotic systems have been applied to factory automation purpose [5, 6]. In the theoretical study, the kinematotropic mechanisms are the reconfigurable mechanisms whose global mobility can be changed with positional parameter actuations at the bifurcation points [7]. A number of kinematotropic mechanisms with single or multiple loops were developed [8-10]. The metamorphic mechanism, a type of reconfigurable mechanism with variable topology and mobility during operation [11], has received wide recognition during the past decade.

From the perspective of kinematic singularity, overconstrained spatial linkages recently emerged as a good resource for designing such advanced mechanisms. Overconstrained linkages with two operation modes were proposed using the type synthesis method [12]. A number of multifunctional $7R$ linkages were designed by the insertion of one overconstrained mobile chain into a closed-loop $7R$ linkage [13]. Recently, the possibilities to design the operation form of a $4R$ linkage with an

overconstrained $6R$ linkage have been also explored [14]. The Bennett linkage is the only spatial overconstrained $4R$ linkage with joint axes neither concurrent nor parallel [15-17]. A number of linkages reported thereafter bear the similarities in using Bennett linkage as the basic element to form more complex overconstrained linkages in the Bennett-based linkage family [18]. Goldberg [19] used two or three Bennett linkages merged on the common links and then collinearly rigidified adjacent links to build $5R$ and $6R$ linkages. More generalized forms of these Goldberg $5R$ and $6R$ linkages could be obtained by varying the kink angles [19, 20]. The $5R$ and $6R$ linkages proposed by Myard [21] and the extended Myard $5R$ linkage [22] were actually special cases of the Goldberg's $5R$ and $6R$ linkages [23]. A hybrid $6R$ linkage was proposed by Waldron [24, 25] with two Bennett linkages sharing a common revolute joint axis. A series of double-Goldberg $6R$ linkages were later constructed using methods similar as Goldberg's [20, 26]. The method of isomerization [27] reveals the connection between linkages in the Bennett-based family and the Bricard-related one [28-30]. Baker [18] proposed variants of the L -shape and serial Goldberg $6R$ linkages, which exhibit different topologies among the Bennett linkages during construction. Using numerical methods, Mavroidis and Roth [31] and Dietmaier [32] found different overconstrained $6R$ linkages exhibit geometric properties of Bennett ratios. These linkages not only share the common elements of Bennett linkages, but also exhibit certain topology of the constructing Bennett linkages to enable motion, which will be addressed in this paper.

One of the most important and fundamental methods to build overconstrained linkages is the superposition (or subtraction) of Bennett linkages on the links sharing the same geometric conditions, which was firstly proposed by Goldberg [19]. Take the generalized Goldberg $5R$ linkage in Fig. 1 as an example. Bennett linkage A is made

of links a/α and c/γ with joints 1, 2, 0, and 5. And, Bennett linkage B is made of links b/β and c/γ with joints 5, 0, 3, and 4. Here, the notion of a/α indicates that the length and twist of this link are a and α , respectively, which could be applied similarly for the other links appeared in this paper. In order to form a Goldberg $5R$ linkage, we firstly superpose linkages A and B on their common link 05 in grey dash lines, and fix the kink angle θ_{kink} between links 20 and 03 to a value. Then, links 20 and 03 are rigidified into one link. After removing the common link 05 and common joint 0, a $5R$ linkage is obtained with single degree of freedom (DoF).

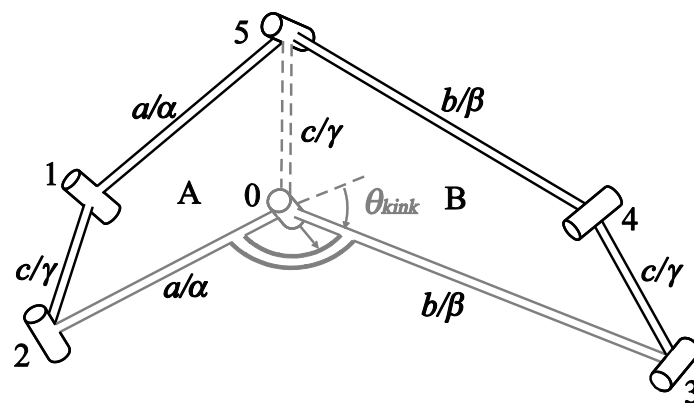

Fig. 1 The generalized Goldberg $5R$ linkage.

Here, in order to design the reconfigurable mechanism among the Bennett-based linkages, the topology of a network with four Bennett linkages is modified by fixing certain joints. This paper is organized as follows. In section 2, a network of four Bennett linkages is introduced and the method to form the possible one-DoF $6R$ linkages is investigated. Section 3 explains the detailed construction and identification for all possible resultant single-loop overconstrained $6R$ and $5R$ linkages. Section 4 demonstrates the reconfiguration among the different cases of the resultant linkages. Conclusion and discussions are enclosed in section 5.

2 A Network of Four Bennett Linkages and its related Bennett-based Linkages

The Bennett linkage requests that the opposite links are with the same link length, twist and Bennett ratio. Then, a network of four Bennett linkages A, B, C and D can be constructed as shown in Fig. 2, which are made of links a/α , b/β , c/γ and d/δ with the same Bennett ratio [15, 16, 23],

$$\frac{\sin \alpha}{a} = \frac{\sin \beta}{b} = \frac{\sin \gamma}{c} = \frac{\sin \delta}{d}. \quad (1)$$

Such a spatial network of four Bennett linkages was firstly discussed by Goldberg [33] when he investigated the type K linkage of Kempe [34] in three-dimensional space. Later, comprehensive analysis about this network was conducted to explore its geometry and its relationship to the Kempe's type K linkage [35, 36]. A single Bennett linkage has one DoF. The DoF of this network can be obtained analytically by setting $\theta_{A,B,C,D}$ as the input of Bennett linkages A, B, C and D, respectively.

$$\theta_A + \theta_B + \theta_C + \theta_D = 2\pi \quad (2)$$

is held for any possible motion configuration. So, three of them are independent to determine the configuration of the network. Therefore, the Bennett network in Fig. 2 has three DoF.

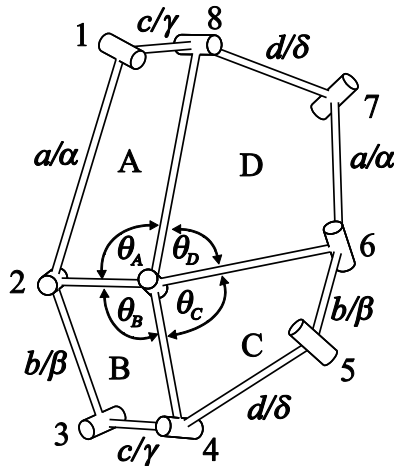

Fig. 2 The network of four Bennett linkages A, B, C and D.

The Bennett-based linkages are a family of four-bar, five-bar and six-bar single-loop overconstrained linkages with only one DoF. In order to explore the relationship between the network of four Bennett linkages in Fig. 2 and its related Bennett-based linkages, the topology has to be modified by reducing the number of active joints in this network to possibly six, five or four, and form a single-loop mechanism with one DoF.

First, in order to reduce the number of links to six, two joints on the peripheral loop are selected and fixed. Thus, the two links connected by such joint on the peripheral loop are rigidified into one link. Next, the four links inside the network are removed to achieve a single-loop mechanism. For the example in Fig. 3, when joints 1 and 4 are selected, the motions of link-pairs 81~12 and 34~45 are constrained. After removing the four links 02, 04, 06 and 08 inside the network, a single-loop mechanism with six active joints, i.e., a $6R$ linkage, can be obtained. Since the DoF of the network is 3, we should expect the resultant $6R$ linkage is one DoF after fixing two joints. Considering the circular sequence of the joint number, there are only six possible combinations on the selection of two joints from the eight joints on the peripheral loop as listed in Table 1, in which the thick solid lines and the black dot in between represent the rigidified link-pair and the fixed joint, and the four links in dash lines and joint 0 are to be removed. Next, we are going to analyse each case individually.

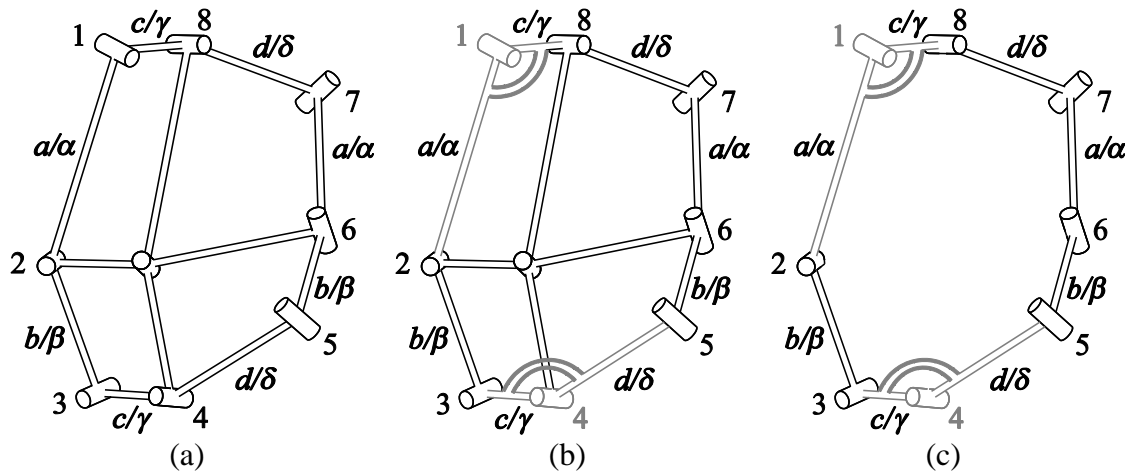
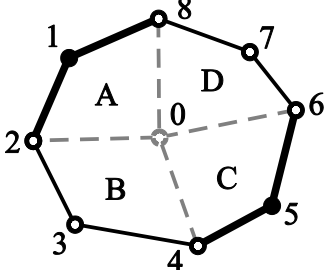
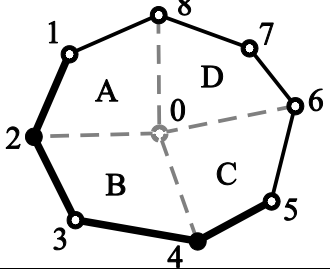
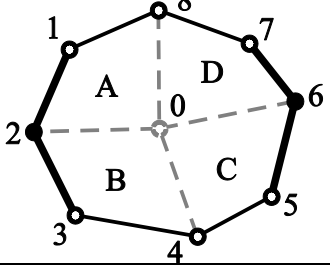

Fig. 3 The modification process demonstrated: (a) the original network; (b) joints 1 and 4 are fixed; and (c) the four links in the center are removed.

Table 1 All possible combinations on the selection of two fixed joints.

Case	Selected 2 joints for fixing (and duplicates)	Simplified representations	Schematics
I	1/2, (or 2/3, 3/4, 4/5, 5/6, 6/7, 7/8, 8/1)	$n/n+1$	
II	1/3, (or 3/5, 5/7, 7/1)	$odd/odd+2$	
III	1/4, (or 2/5, 3/6, 4/7, 5/8, 6/1, 7/2, 8/3)	$n/n+3$	

IV	$\frac{1}{5}$, (or $\frac{3}{7}$)	odd/odd+4	
V	$\frac{2}{4}$, (or $\frac{4}{6}$, $\frac{6}{8}$, $\frac{8}{2}$)	even/even+2	
VI	$\frac{2}{6}$, (or $\frac{4}{8}$)	even/even+4	

3 Network Modification and Linkage Identification

3.1 Cases I&II: Generalized Goldberg 5R Linkage

When joints 1 and 2 are fixed in Fig. 4(a), links 81, 12 and 23 become rigid and Bennett linkages A and B become immobile, i.e. joint 3 is passively fixed and link-pair 80-04 is rigidified as well. Then, the right half of the network with linkages C and D becomes a generalized Goldberg 5R linkage with one DoF. After removing the four links inside the loop, the 6R linkage is in fact a generalized Goldberg 5R linkage with joint 3 immobile. Similarly, when joints 1 and 3 are fixed, i.e. Case II in Table 1, see Fig. 4(b), the left half of the network will be immobile as well, with joint 2 passively fixed. Thus, the network is essentially a generalized Goldberg 5R linkage with only one DoF after removing the four links at the centre. Therefore, Cases I and II linkages are of the same type.

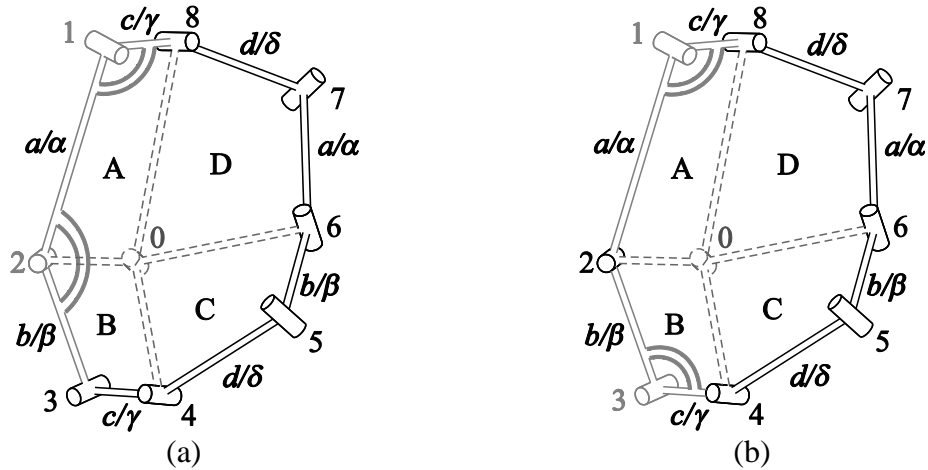

Fig. 4 The modification of the Bennett network into Cases I & II linkages: (a) the Case I linkage with joints 1 and 2 fixed and (b) the Case II linkage with joints 1 and 3 fixed.

3.2 Case III: Generalized Variant of the *L*-shape Goldberg 6R Linkage

As shown in Fig. 5(a), when joints 1 and 4 are fixed, links 82 and 35 are introduced as rigid links. We can identify the resultant linkage by inspecting its special case when link-pairs 81-12 and 34-45 are collinearly rigidified, see Fig. 5(b). Bennett linkage A contracts into a straight line, while joints 0 and 1 are constrained along this line. It forms a variant of the *L*-shape Goldberg 6R linkage proposed by Baker [18]. In the general case that the link-pairs 81-12 and 34-45 are rigidified at any kink angles, the resultant 6R linkage in Fig. 5(a) can be considered as a generalized variant of the *L*-shape Goldberg 6R linkage with one DoF.

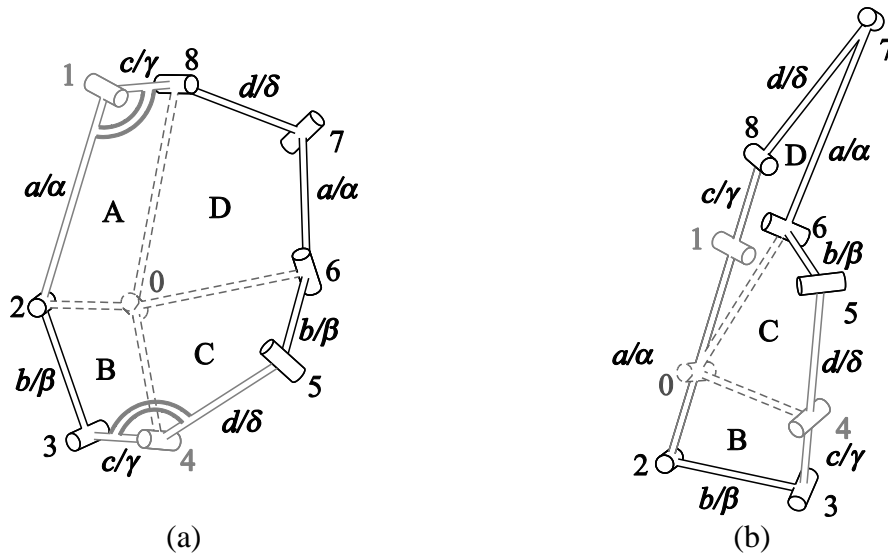

Fig. 5 The modification of the Bennett network into Case III linkage: (a) the schematics of the modification process of Case III linkage; (b) linkage identification in special configuration.

3.3 Case IV: Waldron's Hybrid 6R Linkage

In Fig. 6(a), when joints 1 and 5 are fixed, links 82 and 46 are rigid links. The resultant 6R linkage can be considered as Bennett linkages B and D with the same Bennett ratio sharing the common joint 0. Following the construct method of the Waldron's hybrid 6R linkage, a 6R linkage in Fig. 6(b) can be obtained, which is the same as in Fig. 6(a) kinematically. Therefore the case IV linkage belongs to Waldron's hybrid 6R linkage [24, 25].

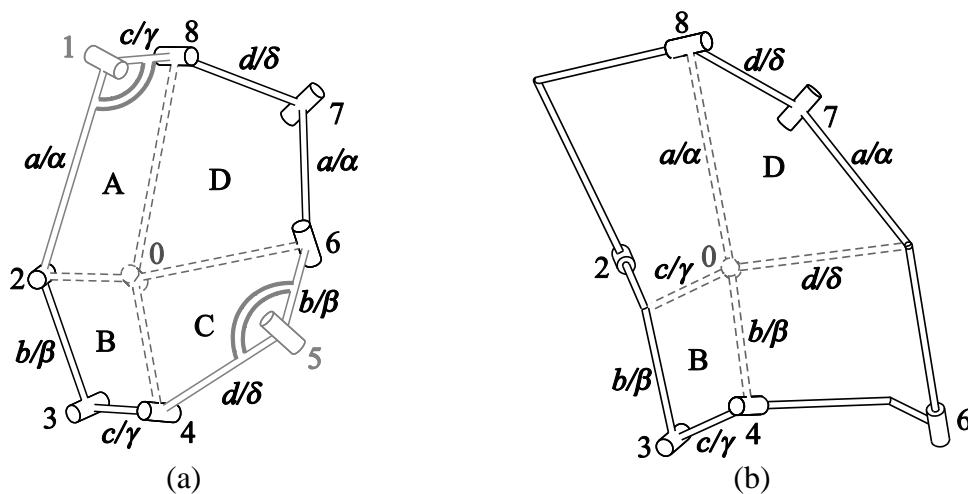

Fig. 6 The modification of the Bennett network into Case IV linkage: (a) the schematics of the modification process of Case IV linkage; (b) linkage identification for the Case IV linkage.

3.4 Case V: Isomerized Generalized L -shape Goldberg $6R$ Linkage

As shown in Fig. 7(a), when joints 2 and 4 are fixed, links 13 and 35 are rigid links. To identify the resultant linkage, we can inspect the loop connected by joints 1, 3, 5, 6, 0 and 8, which is a generalized L -shape Goldberg $6R$ linkage [19]. When replacing link-pair 60-08 by link-pair 67-78 in Fig. 7(b), an isomerized case [27] of the linkage will be obtained. Therefore, the resultant linkage is an isomerized case of the generalized L -shape Goldberg $6R$ linkage, which has only one DoF.

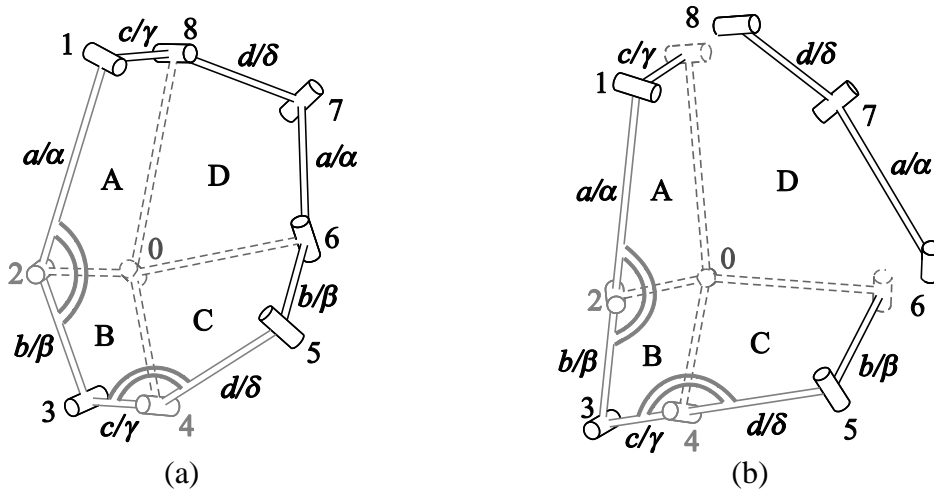

Fig. 7 The modification of the Bennett network into Case V linkage: (a) the schematics of the modification process of Case V linkage; (b) linkage identification for the Case V linkage.

3.5 Case VI: Generalized Wohlhart's Double-Goldberg $6R$ Linkage

In Fig. 8(a), when joints 2 and 6 are rigidified, links 13 and 57 are rigid links. Then Bennett linkages A and B form a generalized Goldberg $5R$ linkage. So do the linkages C and D. The resultant linkage can be identified as the $6R$ linkage merged from two Goldberg $5R$ linkages on common link 80 and 04, see Fig. 8(b), which is in fact a generalized Wohlhart's double-Goldberg $6R$ linkage with one DoF [20].

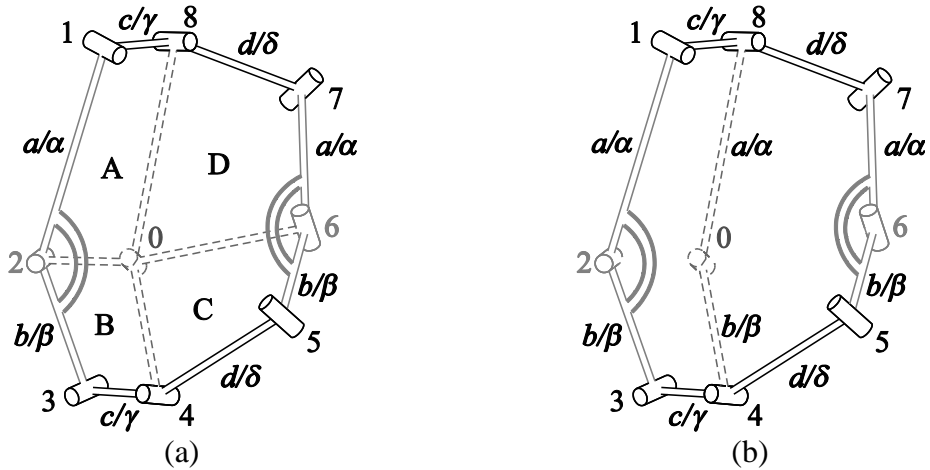

Fig. 8 The modification of the Bennett network into Case VI linkage: (a) the schematics of the modification process of Case VI linkage; (b) linkage identification for the Case VI linkage.

4 Reconfiguration among Five Cases of Bennett-based Linkages

By fixing two of eight joints on the peripheral loop of the Bennett network and removing four links in the centre, there are five linkages obtained. Due to this common construct process, it should be expected that these five linkages can be reconfigured into each other by changing the fixed joints referring to Table 1. For example, the linkage in Fig. 9(a) with joints 1 and 5 fixed is a Case IV Waldron's hybrid $6R$ linkage. Then, we can fix joints 2 and 4 to make the linkage immobile in the current configuration, see Fig. 9(b). After relaxing joints 1 and 5, the resultant $6R$ linkage is mobile, which is the Case V isomerized generalized L -shape Goldberg $6R$ linkage, as shown in Fig. 9(c). Thus, Fig. 9 shows the reconfiguration process between two of five Bennett-based linkages we constructed from the Bennett network.

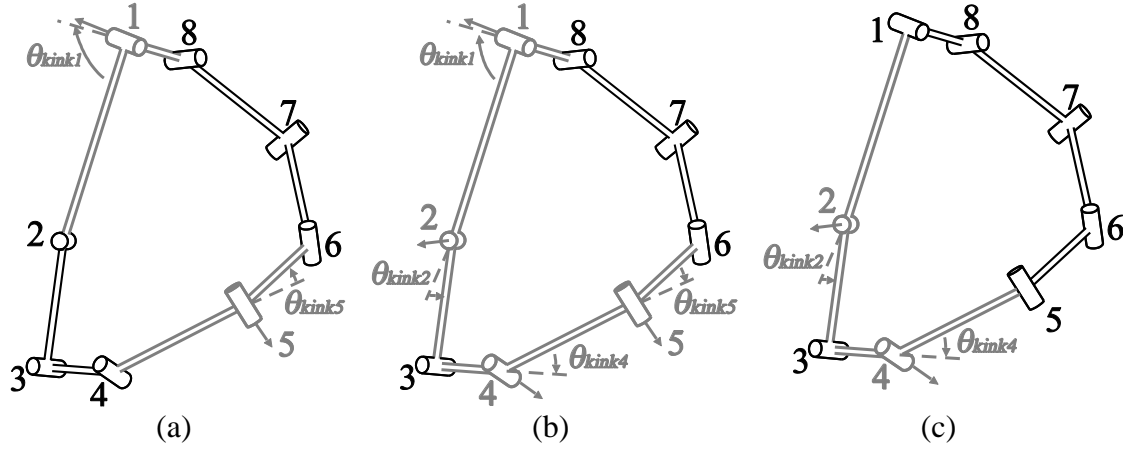

Fig. 9 Reconfiguration process from (a) a Case IV Waldron's hybrid 6R linkage, through (b) fixing kink angles on joints 2 and 4, to (c) a Case V isomerized generalized Goldberg *L*-shape 6R linkage after releasing kink angles on joints 1 and 5.

An example of possible reconfiguration sequence is demonstrated in Table 2 with geometric parameters as Eq. (3). It starts from the Cases I&II Goldberg 5R linkage moving in its own kinematic path marked in black in Fig. 10(a). When it moves to a desired configuration $P_{13(23)}$ where $\theta_4 = -30.00\pi/180$, we could fix joint 4, see Fig. 9(b), and then release joint 2 in Fig. 9(c). As a result, a Case III generalized variant of the *L*-shape Goldberg 6R linkage can be obtained, whose kinematic paths are plotted in the black dash lines in Fig. 10. $P_{13(23)}$ is located at the intersection between the kinematic paths of Cases I (or II) and III linkages. Similarly, move Case III linkage to a desired configuration at P_{34} in Fig. 10(d) with joint 5 fixed and joint 4 released, a Case IV Waldron's hybrid 6R linkage whose kinematic path is in grey solid line in Fig. 10. Furthermore, this linkage is reconfigured into Case V isomerized generalised *L*-shape Goldberg 6R linkage at P_{45} , then into Case VI generalized Wohlhart's double-Goldberg 6R linkage at P_{56} .

$$\begin{aligned}
a &= 1.0000, \alpha = -125.00\pi/180; \\
b &= 0.6104, \beta = -150.00\pi/180; \\
c &= 0.4175, \gamma = -20.00\pi/180; \\
d &= 0.7847, \delta = -40.00\pi/180.
\end{aligned}
\tag{3}$$

Table 2 An example of reconfiguration sequence among all six possible linkage cases from the network of four Bennett linkages.

Revolute variables	Case I	Case II	Case III	Case IV	Case V	Case VI
θ_1	Fixed at $\frac{75.00\pi}{180}$	Fixed at $\frac{75.00\pi}{180}$	Fixed at $\frac{75.00\pi}{180}$	Fixed at $\frac{75.00\pi}{180}$	Movable	Movable
θ_2	Fixed at $\frac{84.68\pi}{180}$	(Passively fixed at $\frac{84.68\pi}{180}$)	Movable	Movable	Fixed at $\frac{26.24\pi}{180}$	
θ_3	(Passively fixed at $\frac{33.06\pi}{180}$)	Fixed at $\frac{33.06\pi}{180}$			Movable	Movable
θ_4	Movable	Movable	Fixed at $\frac{30.00\pi}{180}$	Fixed at $\frac{90.00\pi}{180}$	Fixed at $\frac{40.00\pi}{180}$	Fixed at $\frac{40.00\pi}{180}$
θ_5			Movable		Movable	
θ_6 (output)			Movable	Movable		
θ_7 (input)			Movable	Movable		
θ_8			Movable	Movable	Fixed at $\frac{20.00\pi}{180}$	

The reconfiguration process shown above is only an example for demonstration. Depending on the need of design, one can choose different sets of joints from Table 1 to be fixed, then form a sequence of reconfiguration as Table 2, and finally achieve the reconfiguration among different linkages cases as Fig. 10 with physical model in Fig.11. And the reconfiguration points could be any point on the corresponding kinematic path. It is decided by the kinematic property of different linkages and the desired configurations to conduct the reconfiguration between the linkages.

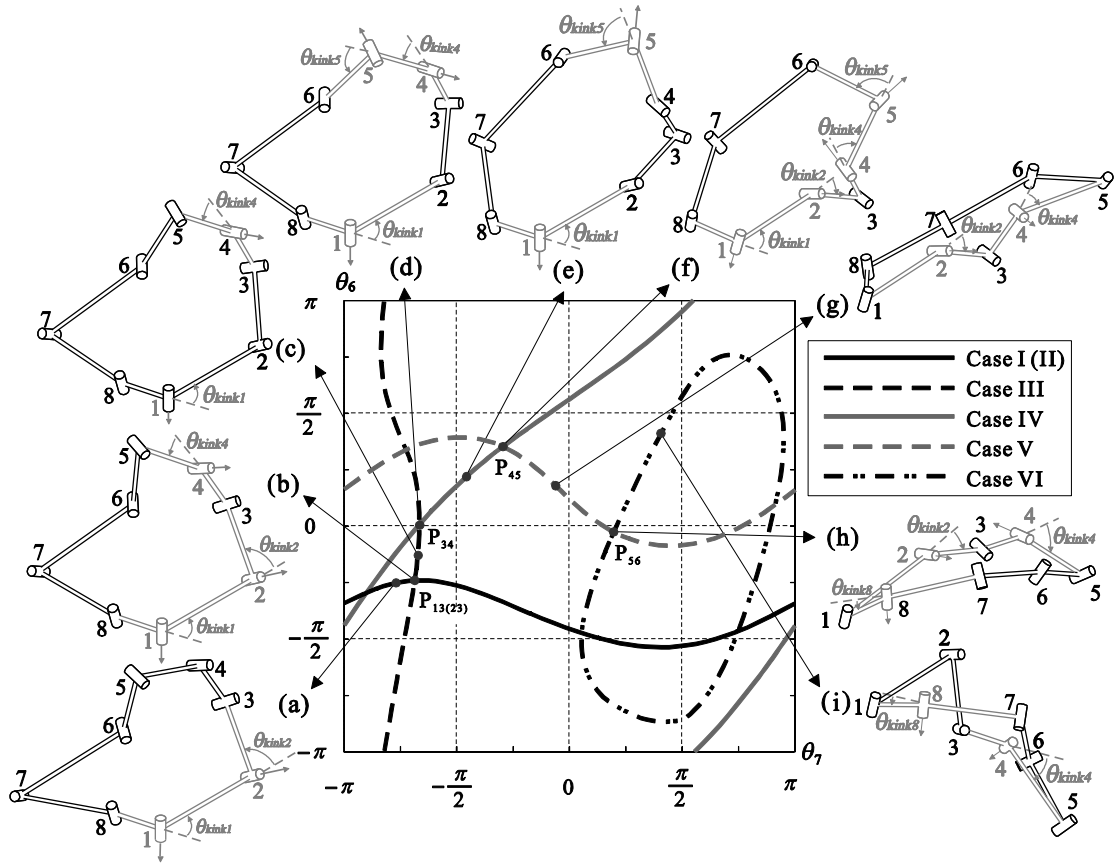
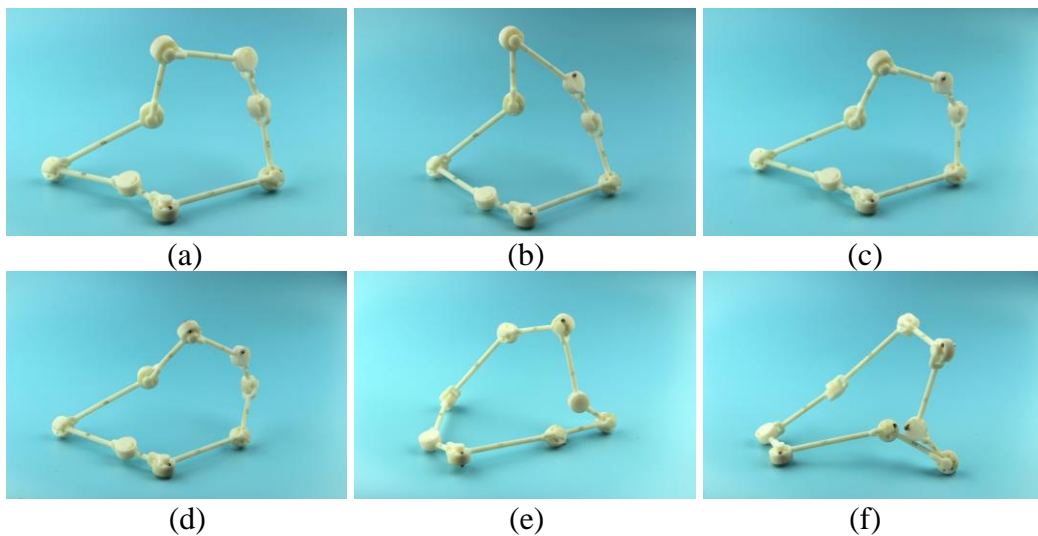

Fig. 10 Map of reconfiguration among five cases of linkages from the Bennett network. The movable joints are in black color and the fixed joints are in grey color. (a) Case I (II) linkage with joints 1 and 2 (or 1 and 3) fixed; (b) reconfiguration from Case I (II) to Case III linkages at configuration $P_{13(23)}$; (c) Case III linkage with joints 1 and 4 fixed; (d) reconfiguration from Case III to Case IV linkages at configuration P_{34} ; (e) Case IV linkage with joints 1 and 5 fixed; (f) reconfiguration from Case IV to Case V linkages at configuration P_{45} ; (g) Case V linkage with joints 2 and 4 fixed; (h) reconfiguration from Case V to Case VI linkages at configuration P_{56} ; (i) Case VI linkage with joints 4 and 8 fixed.



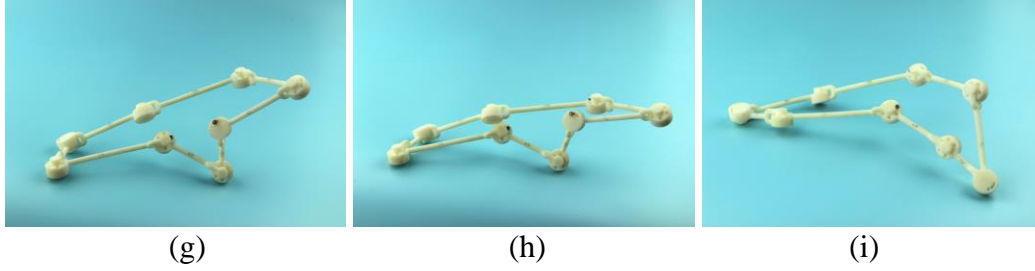

Fig. 11 The physical model to demonstrate the motion and reconfiguration corresponding to Fig.10.

5 Discussions

Besides the $5R$ and $6R$ linkages, it is worth discussing the possibilities to achieve single-loop overconstrained $4R$ linkage, i.e., a Bennett linkage, out of the Bennett network. The geometric conditions of the Bennett linkage require zero offsets on all links [15-17], which essentially requires the rigidified link-pairs to be collinearly posed, making the kink angles to be either 0 or π [37, 38]. As a result, there are two special configurations that are worth noticing. One is when the link-pairs on joints 1, 3, 5 and 7 are constrained into a line, and the network will therefore contract into a line, which is a trivial configuration for a mobile linkage. The other configuration is when the link-pairs on joints 2, 4, 6 and 8 are constrained into a line as shown in **错误!** **未找到引用源。** . In this configuration, the resultant network will have only four movable joints. A single-loop mechanism can be achieved after removing the four links at the centre. The following geometry constraint must be fulfilled to achieve a Bennett linkage.

$$\frac{\sin(\alpha + \beta)}{a + b} = \frac{\sin(\gamma + \delta)}{c + d}. \quad (4)$$

Considering Eqs. (1) and (4), we have

$$\tan \frac{\alpha}{2} \tan \frac{\gamma}{2} = \tan \frac{\beta}{2} \tan \frac{\delta}{2}. \quad (5)$$

Under Eq. (5), Cases V and VI linkages will be degenerated into Bennett linkages with either two or more joints fixed [39]. Then we will get a linkage reconfigurable among Goldberg 5R linkage, generalised variants of *L*-shape Goldberg 6R linkage, Waldron's hybrid 6R linkage and Bennett linkage.

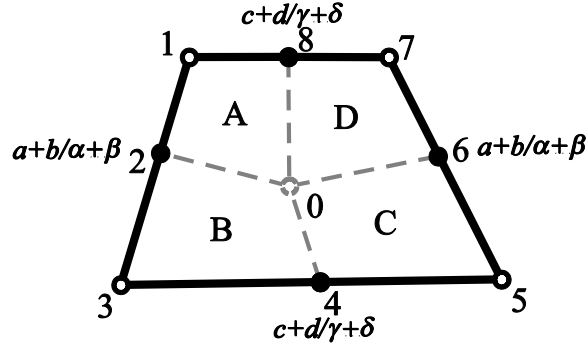

Fig. 11 A special configuration of Bennett linkage from the reconfigurable Bennett network.

Finally, we should point out that the reconfiguration among those five linkages can be conducted at any configuration as long as it can be constructed into the network of four Bennett linkages as we initially proposed. Recent work reveals that the Bennett-based linkages could bifurcate from the constructed form into non-constructed form when the linkages have the collinear configuration, which will be addressed in a later paper. Once the linkage moves into the non-constructed form, which cannot be constructed with two or three Bennett linkages, such as Wohlhart's double-Goldberg 6R linkage [30], it cannot be reconfigured into other Bennett-based linkage by simple changing the fixed joints. Meanwhile, as the 8R linkage formed by the peripheral loop of Bennett network has 3 DoF, its working space will be much larger than the sum of five resultant 5R/6R linkages. So during the reconfiguration, the joints must be fixed first to lock the configuration before releasing the previously fixed joint. Otherwise, the 8R linkage will move to the non-constructive configurations, which will cause the failure of reconfiguration process.

6 Conclusion

In this paper, a network of four Bennett linkages has been proposed. By modifying the topology of this Bennett linkage network, five overconstrained 5R and 6R linkages have been obtained with only one DoF. The resultant linkage cases are generalized Goldberg 5R linkage, generalized variant of the L-shape Goldberg 6R linkage, Waldron's hybrid 6R linkage with zero common offset, isomerized case of the generalized L-shape Goldberg 6R linkage and generalized Wohlhart's double-Goldberg 6R linkage. They were originally derived by using different methods, and now correlated under the same construction basis of the Bennett network. Reconfiguration among these five linkage cases has been realised by fixing different set of joints, which paves the way for potential applications of such reconfigurable mechanisms in engineering design.

Acknowledgement

C.-Y. Song would like to thank NTU for providing the University Graduate Scholarship during his Ph.D. study. Y. Chen and R. Kang would like to thank the financial support from the National Natural Science Foundation of China (Projects No. 51275334, No. 51290293, and No. 51375329) and Tianjin Municipal Science and Technology Department Program (Grants 13JCZDJC26400 and 14JCYBJC19300).

Appendix A

Once the link-pair is rigidified with the fixed joint in the linkage, it is necessary to obtain the geometric parameters of the rigidified. As shown in Fig. A1, link-pair 12-23 and joint 2 are fixed. Then the link 13 can be defined by the geometric parameters a_{13} , α_{13} , R_1 and R_3 , which are equivalent length, twist angle and offsets

of the rigidified link respectively. To calculate these parameters, geometric relationship in the spatial triangle 123 can be used, which leads to

$$\tan \theta'_1 = -\frac{\sin \beta \sin \theta_{kink}}{\sin \alpha \cos \beta + \cos \alpha \sin \beta \cos \theta_{kink}},$$

$$\tan \theta'_3 = -\frac{\sin \alpha \sin \theta_{kink}}{\sin \beta \cos \alpha + \cos \beta \sin \alpha \cos \theta_{kink}},$$

$$\tan \alpha_{13} = \frac{\sin \alpha \sin \theta_{kink} \sin \theta'_3 - \sin \alpha \cos \beta \cos \theta_{kink} \cos \theta'_3 - \cos \alpha \sin \beta \cos \theta'_3}{\cos \alpha \cos \beta - \sin \alpha \sin \beta \cos \theta_{kink}},$$

$$a_{13} = \frac{b \cos \alpha \sin \beta + b \sin \alpha \cos \beta \cos \theta_{kink} + a \cos \alpha \sin \beta \cos \theta_{kink} + a \sin \alpha \cos \beta}{\sin \alpha \sin \theta_{kink} \sin \theta'_3 - \sin \alpha \cos \beta \cos \theta_{kink} \cos \theta'_3 - \cos \alpha \sin \beta \cos \theta'_3}, \quad (A1)$$

$$R_1 = \frac{a \cos \beta \sin \theta_{kink} \cos \theta'_3 + a \cos \theta_{kink} \sin \theta'_3 - b \sin \theta'_3}{-\sin \alpha \sin \theta_{kink} \sin \theta'_3 + \sin \alpha \cos \beta \cos \theta_{kink} \cos \theta'_3 + \cos \alpha \sin \beta \cos \theta'_3},$$

$$R_3 = \frac{(a \cos \alpha \cos \beta \sin \theta'_3 \cos \theta_{kink} + b \cos \alpha \cos \beta \sin \theta'_3 + a \cos \alpha \sin \theta_{kink} \cos \theta'_3 - b \sin \alpha \sin \beta \cos \theta_{kink} \sin \theta'_3 - a \sin \alpha \sin \beta \sin \theta'_3)}{\sin \alpha \sin \theta_{kink} \sin \theta'_3 - \sin \alpha \cos \beta \cos \theta_{kink} \cos \theta'_3 - \cos \alpha \sin \beta \cos \theta'_3}.$$

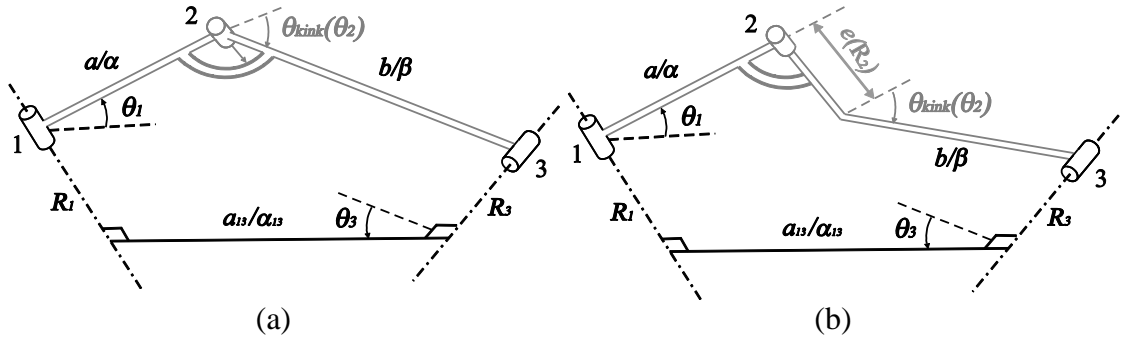

Fig. A1 The geometric parameters of rigidified link: (a) no offset on joint 2; (b) offset on joint 2.

Here, joint angles θ'_1 and θ'_3 are introduced as intermediate variables, which are the differences of the joint revolute variables measured on the original and resultant linkages. Eq. (A1) is only for the situation that the offset on joint 2 is zero as shown in

Fig. A1(a). When there is an offset R_2 on joint 2 as shown in Fig. A1(b), which is the situation for Goldberg 5R linkage in Case I/II, the geometric parameters become

$$\begin{aligned}\tan \theta'_1 &= -\frac{\sin \beta \sin \theta_{kink}}{\sin \alpha \cos \beta + \cos \alpha \sin \beta \cos \theta_{kink}}, \\ \tan \theta'_3 &= -\frac{\sin \alpha \sin \theta_{kink}}{\sin \beta \cos \alpha + \cos \beta \sin \alpha \cos \theta_{kink}}, \\ \tan \alpha_{13} &= \frac{\sin \alpha \sin \theta_{kink} \sin \theta'_3 - \sin \alpha \cos \beta \cos \theta_{kink} \cos \theta'_3 - \cos \alpha \sin \beta \cos \theta'_3}{\cos \alpha \cos \beta - \sin \alpha \sin \beta \cos \theta_{kink}}, \\ a_{13} &= \frac{(b \cos \alpha \sin \beta + b \sin \alpha \cos \beta \cos \theta_{kink} + a \cos \alpha \sin \beta \cos \theta_{kink} + a \sin \alpha \cos \beta - R_2 \sin \alpha \sin \beta \sin \theta_{kink})}{\sin \alpha \sin \theta_{kink} \sin \theta'_3 - \sin \alpha \cos \beta \cos \theta_{kink} \cos \theta'_3 - \cos \alpha \sin \beta \cos \theta'_3}, \quad (A2) \\ R_1 &= \frac{R_2 \sin \beta \cos \theta'_3 - a \cos \beta \sin \theta_{kink} \cos \theta'_3 - a \cos \theta_{kink} \sin \theta'_3 - b \sin \theta'_3}{\sin \alpha \sin \theta_{kink} \sin \theta'_3 - \sin \alpha \cos \beta \cos \theta_{kink} \cos \theta'_3 - \cos \alpha \sin \beta \cos \theta'_3}, \\ R_3 &= \frac{(a \cos \alpha \cos \beta \sin \theta'_3 \cos \theta_{kink} + b \cos \alpha \cos \beta \sin \theta'_3 + a \cos \alpha \sin \theta_{kink} \cos \theta'_3 - b \sin \alpha \sin \beta \cos \theta_{kink} \sin \theta'_3 - a \sin \alpha \sin \beta \sin \theta'_3 + R_2 \cos \theta_{kink} \cos \theta'_3 - R_2 \sin \alpha \cos \beta \sin \theta_{kink} \sin \theta'_3)}{\sin \alpha \sin \theta_{kink} \sin \theta'_3 - \sin \alpha \cos \beta \cos \theta_{kink} \cos \theta'_3 - \cos \alpha \sin \beta \cos \theta'_3}.\end{aligned}$$

Kinematics of the five resultant linkages have been well-studied by other researchers, see the references listed in Table A. The foundation of kinematic analysis in this case is to identify the geometric parameters of rigidified link which have been discussed above. Applying the derived parameters into the closure equations, kinematic analysis of each linkage will be easily accomplished.

From previous work, it can be found that it is difficult to obtain analytical explicit solution to closure equations for some 3D overconstrained linkages. So numerical methods, such as Singular Value Decomposition (SVD) [14,30], has been applied as an effective tool to acquire kinematic paths of the linkages, even to find the new 3D linkages [32]. In this paper, we also used the SVD method to obtain all the

kinematic paths as follows for the five reconfigurable cases with the same geometric parameters given in Eq. (3).

Table A The references on the kinematics of the resultant linkages derived from the reconfigurable Bennett network.

Case	Linkage	Closure equation reference
I & II	Generalized Goldberg 5R linkage	[18, 20]
III	Generalized variant of the <i>L</i> -shape Goldberg 6R linkage	[18, 20]
IV	Waldron's hybrid 6R linkage with zero offset	[18]
V	Isomerized case of the generalized <i>L</i> -shape Goldberg 6R linkage	[18]
VI	Generalized Wohlhart's double-Goldberg 6R linkage	[20]

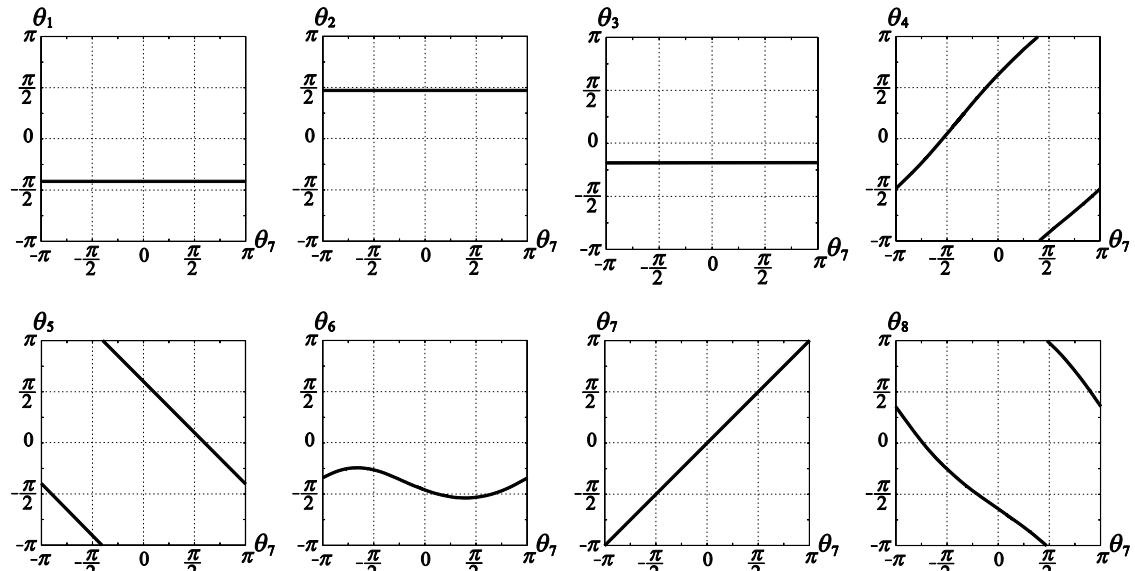
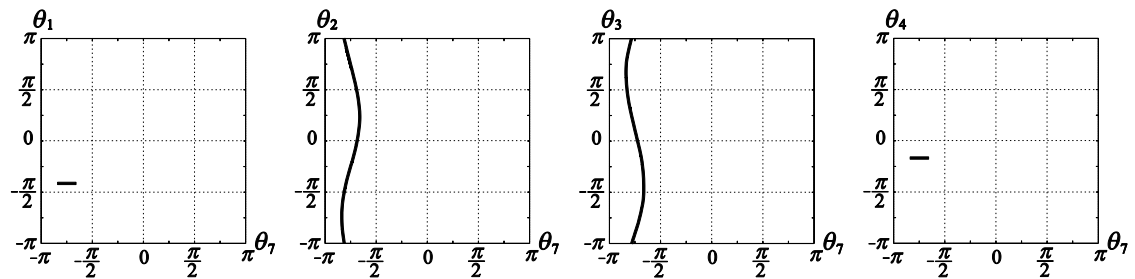

Fig. A2 The kinematic paths of case I & II: generalized Goldberg 5R linkage



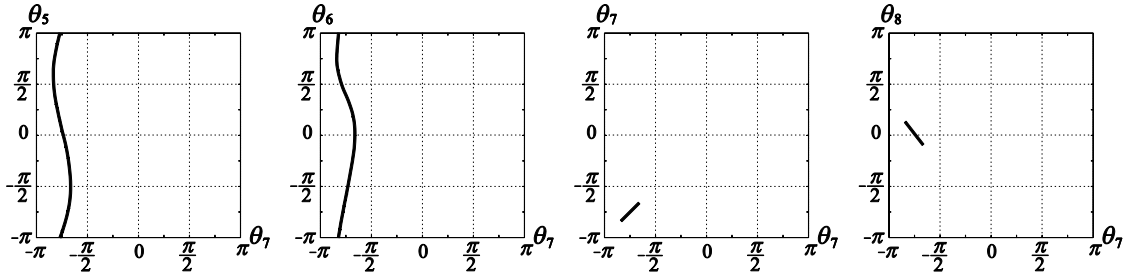

Fig. A3 The kinematic paths of case III: generalized variant of the L-shape Goldberg 6R linkage

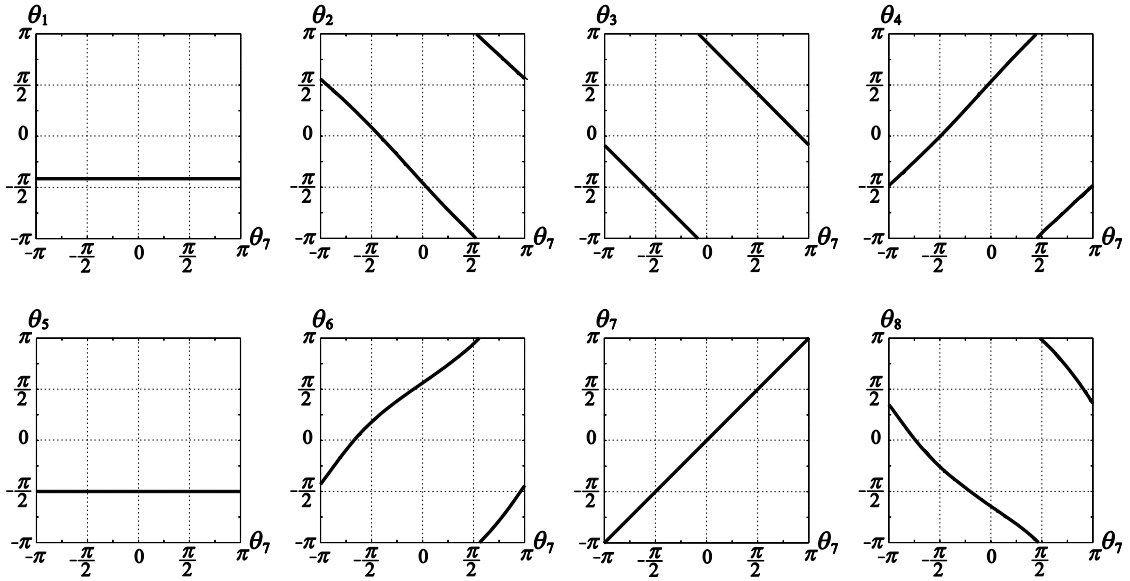

Fig. A4 The kinematic paths of case IV: Waldron's hybrid 6R linkage with zero offset

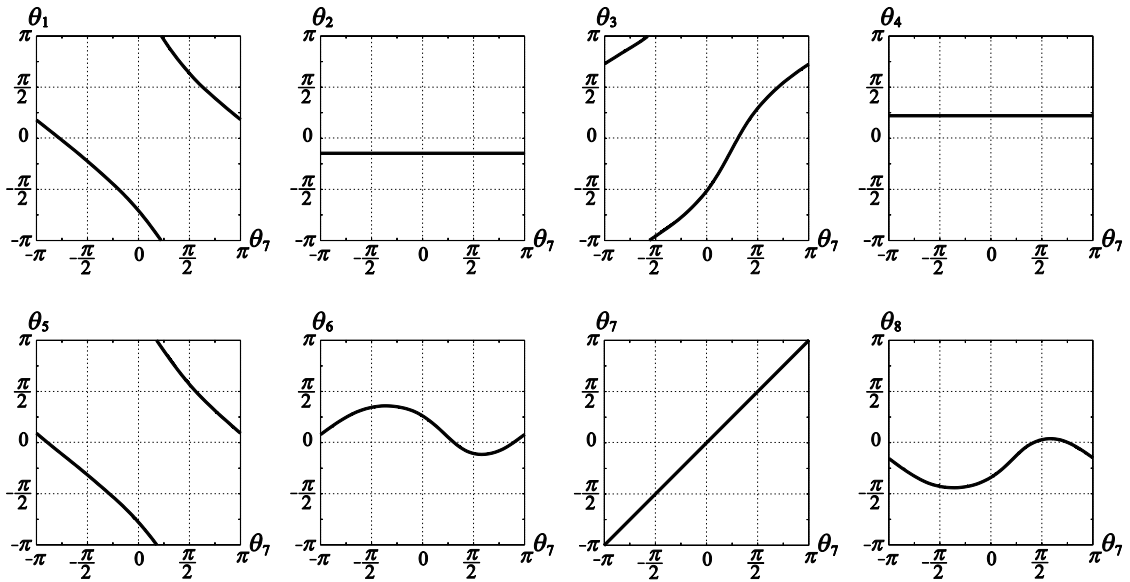

Fig. A5 The kinematic paths of case V: isomerized case of the generalized L-shape Goldberg 6R linkage

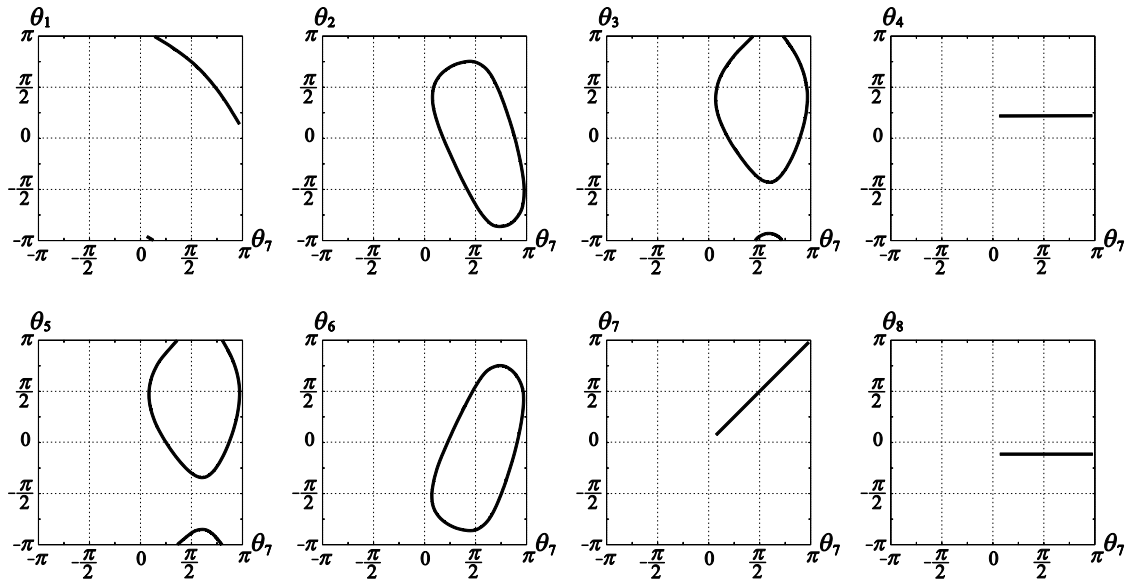

Fig. A6 The kinematic paths of case VI: generalized Wohlhart's double-Goldberg 6R linkage

References

- [1] C.H. Kuo, J.S. Dai, H.S. Yan, Reconfiguration Principles and Strategies for Reconfigurable Mechanisms, Proceedings of the 2009 ASME/IFTOMM International Conference on Reconfigurable Mechanisms and Robots, London, UK, 2009, pp. 1-7.
- [2] I.M. Chen, Theory and applications of modular reconfigurable robotic systems (Ph.D. Dissertation), Mechanical Engineering, California Institute of Technology, Pasadena, CA., 1994.
- [3] T. Fukuda, T. Ueyama, Cellular Robotics and Micro Robotic Systems, World Scientific, 1994.
- [4] M. Yim, Locomotion with a unit-modular reconfigurable robot (Ph.D. Dissertation), Department of Mechanical Engineering, Stanford University, 1994.
- [5] I.M. Chen, J.W. Burdick, Determining Task Optimal Modular Robot Assembly Configurations, Proceedings of the 1995 IEEE International Conference on Robotics and Automation, Nagoya, Japan, 1995, pp. 132-137.
- [6] I.M. Chen, G.L. Yang, Configuration Independent Kinematics for Modular Robots, IEEE International Conference on Robotics and Automation, Minneapolis, MN, 1996, pp. 1440-1445.
- [7] K. Wohlhart, Kinematotropic linkages, in: J. Lenarcic, V. Parenti-Castelli (Eds.) The fifth international symposium on Advances in Robots Kinematics, Kulwer Academic Publishers, Portoroz, Slovenia, 1996, pp. 359-368.
- [8] C. Galletti, P. Fanghella, Single-loop kinematotropic mechanisms, Mech. Mach. Theory, 36 (2001) 743-761.
- [9] C. Galletti, E. Giannotti, Multiloop Kinematotropic Mechanisms, ASME 2002 International Design Engineering Technical Conferences and Computers and Information in Engineering Conference (IDETC/CIE2002) Montreal, Canada, 2002, pp. 455-460.
- [10] C. Galletti, P. Fanghella, Kinematotropic Properties and Pair Connectivities in Single-Loop Spatial Mechanisms, Proc. 10th World Congress on the Theory of Machines and Mechanisms, Oulu, Finland, 1999, pp. 560-565.

- [11] J.S. Dai, J. Rees Jones, Mobility in Metamorphic Mechanisms of Foldable/Erectable Kinds, *Trans. ASME: J. Mech. Design*, 121 (1999) 375-382.
- [12] X. Kong, C. Huang, Type synthesis of single-DOF single-loop mechanisms with two operation modes, *Proceedings of the 2009 ASME/IFTToMM International Conference on Reconfigurable Mechanisms and Robots*, London, UK, 2009, pp. 136-141.
- [13] K. Wohlhart, Multifunctional 7R Linkages, *Proceedings of the International Symposium on Mechanisms and Machine Theory*, AzCIFTToMM, Izmir, Turkey, 2010, pp. 85-91.
- [14] C.Y. Song, Y. Chen, Multiple linkage forms and bifurcation behaviours of the double-subtractive-Goldberg linkage, *Mech. Mach. Theory*, 57 (2012) 95-110.
- [15] G.T. Bennett, A new mechanism, *Engineering*, 76 (1903) 777-778.
- [16] G.T. Bennett, The skew isogram mechanism, *Proc. London Math. Soc.*, s2-13 (1914) 151-173.
- [17] M. Savage, Four-link mechanisms with cylindrical, revolute and prismatic pairs, *Mech. Mach. Theory*, 7 (1972) 191-208.
- [18] J.E. Baker, A comparative survey of the Bennett-based, 6-revolute kinematic loops, *Mech. Mach. Theory*, 28 (1993) 83-96.
- [19] M. Goldberg, New five-bar and six-bar linkages in three dimensions, *Trans. ASME*, 65 (1943) 649-663.
- [20] K. Wohlhart, Merging two general goldberg 5R linkages to obtain a new 6R space mechanism, *Mech. Mach. Theory*, 26 (1991) 659-668.
- [21] F.E. Myard, Contribution à la géométrie des systèmes articulés, *Bull. Soc. Math. France*, 59 (1931) 183-210.
- [22] Y. Chen, Z. You, An Extended Myard Linkage and its Derived 6R Linkage, *Trans. ASME: J. Mech. Design*, 130 (2008) 8.
- [23] J.E. Baker, The Bennett, Goldberg and Myard linkages - in perspective, *Mech. Mach. Theory*, 14 (1979) 239-253.
- [24] K.J. Waldron, Hybrid overconstrained linkages, *J. Mech.*, 3 (1968) 73-78.
- [25] K.J. Waldron, Symmetric overconstrained linkages, *Trans. ASME: J. Eng. Ind.*, 91 (1969) 158-164.
- [26] Y. Chen, Z. You, Spatial 6R linkages based on the combination of two Goldberg 5R linkages, *Mech. Mach. Theory*, 42 (2007) 1484-1498.
- [27] K. Wohlhart, On isomeric overconstrained space mechanisms, *Proceedings of the Eights World Congress on the Theory of Machines and Mechanisms*, Prague, Czechoslovakia, 1991, pp. 153-158.
- [28] R. Bricard, Mémoire sur la théorie de l'octaèdre articulé, *J. Pure Appl. Math.*, 3 (1897) 113-150.
- [29] R. Bricard, *Leçons de cinématique*, Gauthier-Villars, Paris, 1927.
- [30] C.Y. Song, Y. Chen, I.M. Chen, A 6R linkage reconfigurable between the line-symmetric Bricard linkage and the Bennett linkage, *Mech. Mach. Theory*, 70 (2013) 278-282.
- [31] C. Mavroidis, B. Roth, Analysis and synthesis of overconstrained mechanisms, *ASME Design Technical Conferences*, Minneapolis, MI, 1994, pp. 115-133.
- [32] P. Dietmaier, A new 6R space mechanism, *Proceeding 9th World Congress IFTToMM*, Milano, Italy, 1995, pp. 52-56.
- [33] M. Goldberg, A three-dimensional analog of a plane kempe linkage, *Journal of Mathematics and Physics*, 25 (1946) 96-110.
- [34] A. Kempe, On conjugate four-piece linkages, *Proc. London Math. Soc.*, 1 (1877) 133-149.

- [35] J.E. Baker, An analysis of Goldberg's anconoidal linkage, *Mech. Mach. Theory*, 18 (1983) 371-376.
- [36] H.C. Yu, J.E. Baker, On the generation of new linkages from Bennett loops, *Mech. Mach. Theory*, 16 (1981) 473-485.
- [37] A.T. Yang, Application of quaternion algebra and dual numbers to the analysis of spatial mechanisms (Ph.D. Dissertation), Columbia University, 1963.
- [38] C. Mavroidis, B. Roth, On the Geometry of Spatial Polygons and Screw Polygons, *Trans. ASME: J. Mech. Design*, 119 (1997) 246-252.
- [39] C.Y. Song, Y. Chen, A special Wohlhart's double-Goldberg 6R linkage and its multiple operation forms among 4R and 6R linkages, *Advances in Reconfigurable Mechanisms and Robots I*, Springer London, 2012, pp. 45-52.