

IET Generation, Transmission & Distribution

Special issue Call for Papers



**Be Seen. Be Cited.
Submit your work to a new
IET special issue**

**"Emerging Applications of
IoT and Cybersecurity for
Electrical Power Systems"**

**Lead Guest: Editor Mohamed
M. F. Darwish**

**Guest Editors: Mahmoud
Elsisi, Diao-Eldin A. Mansour,
Mostafa M. Fouda and Matti
Lehtonen**

Read more



REVIEW

A comprehensive review of control techniques for compensating the fault current in resonant grounded distribution networks: From the perspective of mitigating powerline bushfires

Warnakulasuriya Sonal Prashenajith Fernando¹ | Md Apel Mahmud¹  |
Shama Naz Islam² | Md Abdul Barik³ | Nasser Hosseinzadeh²

¹Faculty of Engineering & Environment,
Northumbria University Newcastle, Newcastle
Upon Tyne, UK

²School of Engineering, Deakin University, Waurn
Ponds, Victoria, Australia

³Network Planning Department, CitiPower Pty Ltd
& Powercor Australia Ltd, Melbourne, Victoria
3000, Australia

Correspondence

Md Apel Mahmud, Faculty of Engineering, and
Environment, Northumbria University Newcastle,
Newcastle Upon Tyne, NE1 8ST, UK.
Email: md.a.mahmud@northumbria.ac.uk

Abstract

Powerline faults are responsible for major bushfires around the world where arcs provoked from ground faults are common causes for igniting such fires. The grounding techniques (mainly resonant grounding) used in distribution substations and arc suppression devices play a crucial role for compensating fault currents in order to extinguish arcs so that the likelihoods of powerline bushfires are significantly reduced. Though passive arc suppression devices (e.g. Petersen coils) are extensively used for compensating the reactive component of the fault current, the active component of this current is still large enough to ignite the fire in bushfire prone areas for which active arc suppression devices are recently used. These active arc suppression devices incorporate residual current compensation inverters and the full compensation of the fault current rely on the control scheme of these inverters. This paper comprehensively reviews different control schemes that are used for compensating the fault current in resonant grounded power distribution systems. The existing control schemes are discussed in terms of the model used during the controller design process, loop structures, control block diagrams, and performance analysis frameworks (i.e. the type of fault impedances). It is worth mentioning that faults on resonant grounded power distribution networks exhibit the characteristics of high impedance faults and it important to consider this aspect for performance analysis of the control scheme. This paper also covers a brief overview of different grounding techniques used for mitigating fault currents and finally, the challenges with the existing controllers are identified in terms of extinguishing powerline bushfires. The comprehensive review motivates and guides future research activities on developing more efficient fault compensation techniques.

1 | INTRODUCTION

Bushfires provoked by powerlines have been a major cause for concerns in Victoria (an Australian state) for the past few decades. The most notable incidents in Victoria include the 12 February 1977 bushfire, 16 February 1983 (Ash Wednesday) bushfire, 7 February 2009 (Black Saturday) bushfire, 2019–2020 (Black Summer) bushfire which led to severe losses of lives and properties. Bushfires can be aroused by natural events (e.g. lightning), human activities (e.g. campfires, arson etc.) and few

others (e.g. powerlines). While powerlines only account for 1 to 4 percent of the bushfires per year, these have been disproportionately catastrophic [1, 2]. It must be noted that the emphasis here is on power distribution lines. The reason for such considerations is that transmission lines are responsible for much lesser fires as the design, operation, and maintenance schemes for these transmission networks commensurate the criticality.

Faults in powerlines can ignite bushfires where these faults typically occur when vegetation comes into contact with the

This is an open access article under the terms of the [Creative Commons Attribution](https://creativecommons.org/licenses/by/4.0/) License, which permits use, distribution and reproduction in any medium, provided the original work is properly cited.

© 2022 The Authors. *IET Generation, Transmission & Distribution* published by John Wiley & Sons Ltd on behalf of The Institution of Engineering and Technology.

powerlines, wind causing powerlines to touch each other, heat causing the lines to sag and come into contact with each other and lightning strikes [1]. This creates large current flows leading to sparks and electric arcs which can cause ignitions. Single line-to-ground (SLG) faults are the most commonly occurring faults ($\approx 70\%$ of all possible faults) in both polyphase and single wire earth return (SWER) lines [1]. There are chances of line-to-line and three-phase faults but these are less significant when compared to SLG faults. Recently, a study has been carried out on the probability of bushfire ignitions from electric arcs by focusing on how different variables such as the magnitude of the arc current (i.e. the fault current) and duration along with environmental factors like wind speed, ambient temperature and moisture, and type of fuels (plantations) under the worst-case conditions affect the probability of ignition [3]. The results showed that an arc can ignite fire almost instantaneously (less than 10 ms). However, this was highly dependent on the arc current duration, magnitude, and other environmental factors. Even a moderate airflow would be sufficient to extinguish any arcs, particularly with low fault currents [3]. There was 50% chance of sustained ignitions when the magnitudes of the fault current and durations are 200 A for 60 ms and 4.2 A for 155 ms.

Various recommendations have been proposed to enhance the protection of polyphase and SWER powerlines in distribution networks as an attempt to minimize and ideally mitigate bushfire ignitions due to powerline faults. Rapid earth fault current limiters (REFCLs) have been proposed for polyphase powerlines while newer generation auto circuit recloser (ACR) devices have been recommended for SWER lines. The third option of underground cabling or insulated cabling has also been proposed which is applicable for both polyphase and SWER lines [4]. The discussion of ACRs and underground (or insulated) cabling is beyond the scope of this paper as this work mainly stresses the compensation of the fault current in three-phase power distribution systems due to SLG faults which are responsible for 70% of powerline bushfires [1].

Another important factor needs to be considered, when discussing the fault protection in distribution networks, is the system grounding. The system grounding plays a crucial role for the fault compensation in distribution networks. Hence, distribution networks with the grounding are termed as compensated distribution networks. The grounding in a distribution network is essential to control the line-to-ground voltage within certain thresholds in order to minimize the stresses on the insulation of conductors during faults. This also reduces the risk of electrical shock hazards to personnel and equipment that might come into contact with the faulty conductor. Although fault detection is beyond the scope of this paper, the grounding reduces communication interferences paving the way for rapid fault detection [5]. Another important contribution of grounding is that it provides a path for the fault current to flow during a faulted condition which would subsequently trigger protection devices that would isolate voltage sources from the faulty conductor. Apart from that, the effectiveness of grounding can influence the system reliability, power quality, and longevity

of customer and utility equipment. The effective grounding is an intentional connection to the ground either directly or via a sufficiently low impedance having adequate current carrying capacity to limit the buildup of hazardous voltages [6]. As indicated in ref. [7], understanding the impact of grounding systems on the transient current is crucial to determine the effectiveness of the protection system provided by these groundings.

In most power systems, the neutral is grounded at one or more points where grounding grids are used in high voltage stations situated in rocky terrains and multiple grounding conductors are buried to a depth of 1 to 2 feet as it is impractical to use deep-driven conductors due to the rocky nature of the soil [8]. The neutral grounding can be either solid (which is a direct connection to the ground) or an impedance-based grounding (systems with ungrounded neutrals are typically not recommended). The impedance grounding can further be broken down as resistive grounding, reactive grounding, and resonant grounding (also known as the ground fault neutralizer) [9]. A real case study is performed in ref. [10] on medium voltage networks where ground fault characteristics are analysed for the high impedance grounding. The results in ref. [10] show that only a few arc faults occur in compensated networks and the ground fault arcs could self-extinguish without any auto-reclose feature, thus, improving the supply reliability of the network. The voltage transformer-based grounding is used particularly if the primary or secondary coil of a transformer is in delta configuration (with no convenient neutral) where the voltage transformer is used to ground the delta side. A zigzag transformer is used in systems with high voltages (>33 kV) as it provides an added benefit of limiting high fault currents by equally dividing these into all three phases [11]. All these grounding schemes have their own distinctive features and each technique is meant to serve a certain purpose.

The concept of rapid earth fault current limiters (REFCLs) comes into the context with the resonant grounding which injects current at the neutral point for compensating the fault current and faulty phase voltage. In fact, the resonant grounding provides self-extinction of arcs in overhead lines for about 80% of temporary faults without tripping feeders [5, 12]. The study carried out in ref. [13] shows the advantage of the resonant grounding over resistor grounding (which has been a popular grounding technique for a while). A systematic review of the flexible grounding technique to compensate the fault current due to the high impedance single-phase to ground fault is carried out in ref. [14] though it does not focus the control aspect of the residual current compensator (RCC) inverter. During a high impedance ground fault, the damage at the fault point is 19 times more in a resistor grounded system while comparing with the resonant grounded (RG) system. REFCL devices limit the fault current during SLG faults almost instantaneously. REFCL simulations as presented in [3] show that no ignition is provoked due to arcs during SLG faults. While REFCLs are greatly beneficial in minimizing the risk of bushfire ignitions due to electric arcs, it must be noted that they cannot handle complex faults involving multiple conductors (e.g. line-to-line faults, double

line-to-ground faults, three line-to-ground faults etc.). REFCLs limit the fault current using passive and active fault current compensation. Passive fault current compensation utilizes resonant grounding (ground fault neutralizers or arc suppression coils) to compensate the capacitive currents in the distribution network during an SLG fault. Over the years, the resonant grounding has been a popular choice due to its ability for the effective compensation of the fault current [15, 16]. This does not mean that arc suppression coils are perfect as these still suffer from resonance-related issues leading to overvoltages which can lead to dangerous results like insulation stresses, voltage asymmetry during non-faulty conditions, harmonics, and few others to mention [17].

The passive compensation (also known as the arc suppression coil, i.e. ASC) cannot fully compensate ground fault currents in distribution networks. As noted earlier on, the active component of the ground fault current has become more prominent due to the expansion of the network and it cannot be neglected as its magnitude during faults can be sufficient to provoke arcs that can lead to sustained ignition of bushfires. Apart from these, the increase in nonlinear loads causes harmonics in the ground fault current which in turn increases the chances of the arc ignition factor as these harmonics cannot be neutralized by passive compensators. Therefore, these issues have geared more research towards active and harmonic compensation of ground fault currents and it is essential to have the compensation technique that can compensate the active component of the fault which is typically carried out by RCC inverters. An RCC inverter-based ground fault neutralizer (GFN) as implemented in ref. [12] demonstrates the full compensation (both active and reactive) with a response time of less than three cycles. However, this compensation totally relies on the control schemes used for the RCC inverter.

The control of the RCC inverter for compensating the fault current in RG distribution systems is relatively a new area. This paper aims to provide a comprehensive overview of different control schemes that are used for compensating the fault current in RG power distribution systems along with a brief overview of different grounding techniques. The control techniques are analysed by dividing into several groups and subgroups depending on the use of the model for the ASC with the RCC inverter. The performance summary of these control techniques in terms of the fault current and faulty phase voltage compensation is also presented in this paper while considering the fault impedance. Finally, major challenges and research gaps are identified in terms of compensating the fault current and faulty phase voltage for mitigating powerline bushfires.

The rest of the paper is organized as follows. A brief overview of different grounding techniques is presented in Section 2 while Section 3 provides a comprehensive overview of different control schemes used for the RCC inverters in resonant grounded distribution systems. The challenges are presented in Section 4 and finally, the paper is concluded in Section 5 along with some future directions.

2 | A BRIEF OVERVIEW OF DIFFERENT GROUNDING TECHNIQUES AND FAULT CHARACTERISTICS

As indicated earlier on, a grounded system can be classified as a neutral or non-neutral grounded system along with an ungrounded system where there is no intentional connection to the earth. The neutral grounding in a system can be done at one or more points by mainly focusing on extra-low and extra-high voltage systems [9]. On the other hand, the non-neutral grounding is not solely used for the power generation or distribution and it is typically used for grounding the buildings, utility grids, and substations [11, 18]. This section aims to provide a brief overview of different grounding techniques (mainly, neutral grounding such as solid, resistance, reactance, and resonant groundings) along with an ungrounded system as discussed in the following subsections.

2.1 | Ungrounded systems

Figure 1(a) shows an ungrounded system from where it can be seen that there is no intentional ground in this system. This is technically inaccurate as there is a capacitive coupling between the conductors of the system and ground. However, these capacitances have a very limited impact on grounding characteristics, hence, the notion of an ungrounded system being the capacitive grounded is disregarded [9]. Harmonics in an ungrounded system can be ignored due to the absence of a ground and their effects would die out themselves within the system. However, there is very poor protection against transient overvoltages in an ungrounded system which can lead to the gradual deteriorations and breakdown of insulations [11].

In an ungrounded system without any fault, the line-to-ground capacitance is generally assumed as balanced and the capacitance-to-ground currents of each phase are equal in magnitude with the phase shift of 120° from each other. Therefore, the algebraic sum of these currents will be zero. When there is an SLG fault on any of three phases, the current flowing through the faulty phase will cease as there will be no potential difference due to the grounding of that phase. The voltages of the healthy phases will rise from the line-to-neutral voltage to the line-to-line voltage while the phase voltages will no longer be shifted by 120° rather by 60° . Accordingly, the capacitor charging currents will be 1.732 times of the nominal value. Unlike the non-faulty condition, the algebraic sum of the current flowing through the capacitances will no longer be zero but it will be three times of the nominal value while the fault current will lead the original phase voltage by $\approx 90^\circ$. This scenario shows some problems in an ungrounded system. Due to the resonance provoked from the inductance of the system and the distributed capacitances to the ground, there can be transient overvoltages which may cause damages to insulations at multiple points [9, 11]. Transient overvoltages from restriking ground faults have persuaded to limit the use of ungrounded systems and

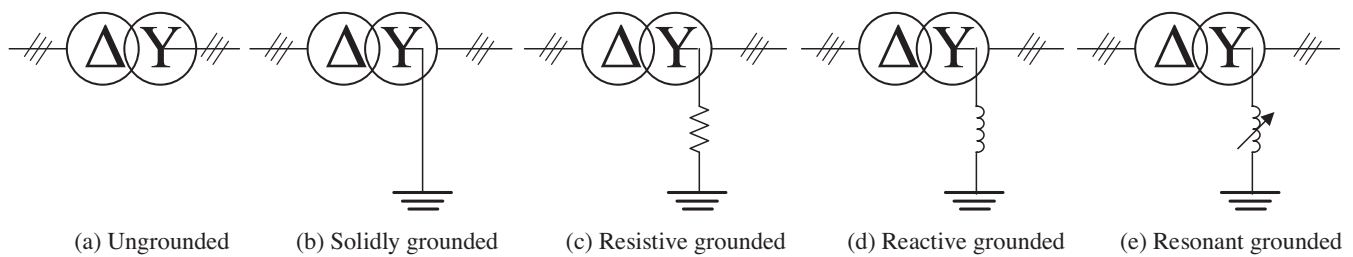

FIGURE 1 Different types of grounding techniques

move towards solid or impedance grounding. Despite these issues, an ungrounded system may still remain operational during sustained faults with lower magnitudes as the phase-to-phase voltage triangle remains intact. Apart from that, the self-extinction of low-intensity ground faults is possible on overhead ungrounded lines [5].

2.2 | Solidly grounded systems

A solidly grounded system is one where the neutral is directly connected to the ground with no impedance which can be seen from Figure 1(b). Typical solid groundings are used in generators as they provide fast clearing times for high fault currents [11]. In practice, the solid grounding in distribution systems can be either uni- or multi-grounded. In a three-wire uni-grounded system, all loads are connected between phases whereas in a four-wire uni-grounded system, there is an isolated neutral with loads being connected between phase and neutral. Here, the imbalance in the load current returns via the neutral while the ground fault current returns through the ground to the neutral of the substation. In four-wire multi-grounded systems with phase-to-neutral loads, the system is grounded at each transformer in the substation [5].

2.3 | Resistive grounded systems

In contrast to the solid grounding, the neutral is grounded via an ohmic resistor in a resistance grounded system as presented in Figure 1(c). There are low resistance grounding (LRG) and high resistance grounding (HRG) techniques including the existence of a third technique which is a hybrid that includes both LRG and HRG. The ultimate objective of the resistance grounding is to limit the fault current through the grounding conductor for reducing the risk of electrical shock hazards, arc blasts or flash hazards, and stresses on apparatus carrying fault currents as well as to securely control transient overvoltages while at the same time avoiding a faulted circuit shutdown. An LRG scheme is used to maintain the fault current within certain limits to protect the insulation of the grounding conductor [11] where the fault current is typically limited to a range of 50 to 1000 A [9]. HRG systems are used with medium voltages

typically in the range of 150 to 600 V [11] where the fault current is limited to 10 A or less [9]. A drawback of HRG systems is that it takes more time to drain out the fault current as compared to LRG or solidly grounded systems. LRG systems exhibit a particular disadvantage that is the simultaneous grounding of generators and/or transformers results in a low equivalent impedance as the impedances are in parallel. This scenario would lead to very high fault currents in the system (in the order of 1000 A). To mitigate the drawbacks of LRG and HRG systems and achieve the optimal use of the resistance grounding, a hybrid, i.e. the combination of LRG and HRG is adopted where the system adaptively switches the grounding in a generator from an LRG source to a HRG source during a ground fault [9].

2.4 | Reactive grounded systems

In a reactance grounded system, the system neutral is grounded via a reactor as shown in Figure 1(d). The fault current in a reactance grounded system should be limited in such a way that it has the lowest value of 25% (though 60% is preferable) of the three-phase fault current for preventing transient overvoltages [19]. The reactance grounding is generally used in cases where it is necessary to limit the magnitude of the ground fault duty to a value similar to that of a three-phase fault. The use of a reactance grounding for limiting the fault current is relatively less expensive than resistance grounding particularly if the magnitude of the desired current has several thousand amperes. There are two possible scenarios where these situations can arise. In one scenario, the total zero-sequence impedance of step-down transformers in medium voltage distribution networks can cause the fault current (due to an SLG fault) to exceed that of a three-phase fault. Another instance is when a generator must directly supply a single-phase load at its terminal (without the presence of a generator isolation transformer). If there is an unbalance, a residual current will pass through the neutral of the generator. Generators in medium voltage networks cannot handle mechanical forces provoked from such fault currents whose values exceed due to a three-phase fault at the terminal of a machine. For this reason, the solid grounding is not desirable and a low reactance grounding is adopted for limiting the ground fault current to a value below the corresponding three-phase value [9].

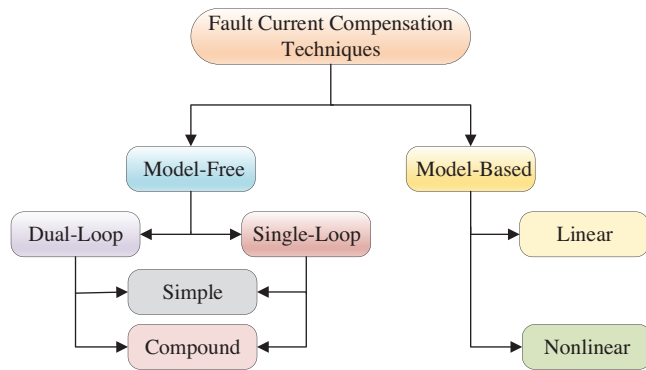

FIGURE 2 Classifications of fault current compensation techniques

2.5 | Resonant grounded systems

In an RG system, the neutral is grounded via a variable reactor as shown in Figure 1(e) which is also called the GFN or the Petersen coil or ASC. The impedance of the reactor is tuned to match the total zero-sequence capacitive reactance of the distribution network, thus, negating the effect of the capacitive ground fault current. When an SLG fault is considered on any of three phases, the faulty phase voltage will be impressed across the variable reactor for generating a lagging current as the reactor is inductive. Hence, there will be a closed path for the current to travel through the reactor, transformer, the ground fault, and then to the ground. On the other hand, the leading capacitive current (which is three times of the nominal value) flows via line-to-ground capacitances of the healthy phases due to the fault. Since the internal resistance of the variable reactor is relatively small, the lagging inductive current and the leading capacitive current are assumed to be 180° out of phase [20]. Hence, the phasor sum of the inductive and capacitive components of the ground fault current will be zero if the reactor is properly tuned [9]. Only a small residual current exists due to the resistive component. RG systems are sometimes called compensated systems and depending on the relationship between the inductance and capacitance, the reactive impedance can be off-tuned, thus, resulting in over- or under-compensation. With the RG, a system is capable of reducing the fault current around 3% to 10% to that of an ungrounded system and with modern techniques like the moving core reactor with a control system, 100% tuning for all system operating conditions can easily be achieved [5]. An automatic tracking Petersen coil has two operating modes: the pre-setting and the follow-setting modes. As discussed in ref. [21], with the pre-setting mode, the system capacitance is measured in the real-time which allows the compensation as soon as an SLG fault occurs. The drawback of this method is that during the normal operation of the system, i.e. without any fault; the displacement voltage of the neutral point is high for which a buffer resistance is required to prevent series resonance. In the follow-setting mode, the coil is adjusted to properly inject an inductive current to the system to compensate the capacitive current immediately after a fault and as the displacement voltage is lower for which a separate buffer resis-

tance is not required to prevent any series resonance. This mode, however, takes longer to achieve arc extinction.

This paper concentrates on the fault current and faulty phase voltage compensations in RG power distribution networks as this resonant grounding technique is used for powerlines in bushfire prone areas. The following section discusses different techniques for compensating the SLG fault in RG power distribution networks.

3 | DIFFERENT FAULT CURRENT COMPENSATION TECHNIQUES FOR THE RCC INVERTER

Depending on the nature of the fault current compensation in RG distribution networks the passive compensation in distribution networks involves the use of resonant grounding (i.e. arc suppression coils and ground fault neutralizers) to compensate the fault currents during SLG faults. As mentioned before, the proper tuning of arc suppression coils has proven to be highly effective in neutralizing ground fault currents. The device used as the arc suppression coil is the Petersen coil invented by Petersen in 1916 [22]. Over the years, the Petersen coil has seen several iterations with modern networks utilizing coils adapting to the variations in line-to-ground parameters in distribution networks [23]. The active portion of the ground fault current has received lesser attention in the past as it has not been very significant. In fact, if the active component of the ground fault current is 5% of the capacitive current or less, it is neglected as its magnitude is not sufficient to provoke any arcs or cause any danger [1]. While the distributed capacitances are responsible for the capacitive ground fault currents, the shunt leakage resistors are responsible for the active component of the ground fault current. Over the years, the power distribution network has seen extensive growth and expansion with almost everyone gaining access to electricity. However, this expansion has also caused the line-to-ground capacitances to significantly increase [24]. This is coupled with insulation deterioration due to aging, bad weather and environmental conditions which have caused the effects of the active component of ground fault currents to become more significant. In ref. [25], it has been indicated that the active component of the ground fault current may exceed 10% pu in overhead distribution networks which can be sufficient to provoke arcs and subsequently even bushfires. Other components that are not compensated by passive techniques are the harmonics which appear due to the nonlinearity of the power transformers, mutual inductors, and presence of nonlinear loads [25].

The traditional passive arc suppression device (ASD), i.e. the Petersen coil is limited in its functionality in achieving full fault current compensation where both active and reactive components (including the harmonics) are to be neutralized. Therefore, active ASDs, which are also called residual current compensators (RCCs), or flexible arc suppression devices (FASDs); are used to achieve the full compensation. Active ASDs typically utilize power electronic inverters (e.g. voltage

source inverters with different topologies and modulation schemes) to effectively compensate the fault current. For example, a ground fault neutralizer with the RCC inverter is proposed in refs. [12, 26] to achieve the full compensation of ground faults in RG transmission networks. However, distribution networks are more prone to powerline bushfires which can be evidence from the report by the Powerline Bushfire Safety Taskforce [1]. In the existing literature, the term flexible is used to represent the characteristics of the power converters which are capable to flexibly control the output current of the RCC inverter [27]. Based on the location of the installation and structure, FASDs can be classified into two major parts: three-phase arc suppression method at bus bar and single-phase arc suppression method at the neutral point [28]. The fault current compensations of these active ASDs have their own advantages and disadvantages.

3.1 | Classifications of compensation techniques

This subsection focuses on the different control techniques adopted by various ASDs. The arc suppression methods used by these devices typically fall into the category of current-based suppression or voltage-based arc suppression. The ultimate objective, in either case, is to eliminate ground fault arcs (i.e. full compensation of the ground fault current). The control techniques adopted by these ASDs are crucial for their steady-state operations where the control objective is to achieve fast and accurate arc suppression [28]. Based on the design and implementation of existing control schemes, these can be divided into two broad categories: model-free and model-based schemes. Here, the model-free controllers do not require the exact model of ASDs, e.g. proportional-integral (PI) controllers. On the contrary, the model-based control scheme will require the dynamic model of ASD such as the H-infinity control scheme. The model-free scheme can further be classified as the single-loop and dual-loop controllers. In the single-loop control structure, there is only one loop which is used for compensating the fault current. On the other hand, the dual-loop controllers have an inner loop and an outer loop where the outer loop is used to generate the reference value for the inner loop depending on the structure of the controller. Furthermore, there can be more than one control scheme within a loop, i.e. two controllers can be combined in a single loop to form a compound structure. Hence, both single- or dual-loop controllers can further be categorized as simple and compound structures. On the other hand, the model-based control scheme includes linear and nonlinear controllers which can also be classified in a similar manner to that of model-free controllers. However, the existing literature only includes the single-loop structure for model-based controllers and hence, these are not further classified in terms of loops. All these classifications are shown in Figure 2 and a detailed overview of these controllers is provided in the following subsections.

3.2 | Model-free single-loop control schemes

As mentioned earlier in this section, the single-loop control structure includes only one loop with one or more control schemes within that loop. These model-free controllers are mainly designed using PI controllers in conjunction with either advanced modulation schemes including new topologies or other control schemes such as the proportional (P) or proportional resonant (PR) controllers. It is worth mentioning that the PR controller uses some information from the system model. However, it is considered with the model-free scheme as the PI controller is used as the main control action with the compound PI+PR for the fault current compensation in RG grounded power systems. Both simple and compound single-loop controllers are discussed in the following.

3.2.1 | Simple single-loop controllers

The simple single-loop controllers include traditional closed-loop controller [29], PI controller [30], PI controller with an advanced topology [31], and PI controller with an improved modulation technique [22] which are discussed in details through the following points.

(a) Closed-loop controller [29]: The risks of electric shocks due to SLG faults are analysed in ref. [29] by controlling ASDs so that the fault current can be minimized. In ref. [29], the reference value of the injected current is calculated using the zero-sequence phase current of the faulty phase and load current. Here, this load current is also used to calculate the voltage drop between the substation bus and the fault point where this point is calculated using the travelling wave positioning technique. Usually, the line voltage drop is considered to be small enough and ignored. However, there are some situations where this might not be the case, and even though the faulty phase voltage is suppressed to zero, there are chances that a large current and voltage to be present at the fault point which can make it difficult to completely extinguish arcs. In ref. [29], the inverter with the ASD is controlled using a closed-loop controller (without specifying any technique) for suppressing the faulty phase voltage to zero by regulating the current injection so that the arc can be suppressed. The performance of the controller is simulated on a 10 kV distribution network by considering the fault impedance between 50 Ω and 2 k Ω for which the compensated value of the fault current lies between 0.067 and 0.026 A while the faulty phase voltage becomes between 3.4 and 50.2 V. However, the value of the fault current for the similar fault impedance but without any current injection by the RCC inverter is between 48.5 and 2.6 A while the faulty phase voltage is between 2450 and 5175 V. Though the approach in ref. [29] is useful, it depends on the identification of the fault location which is not easy for RG distribution networks as the traditional protection devices cannot detect the fault due to the compensation by the ASC.

(b) PI controller [30]: The PI controller is the most commonly used method for the fault current compensation in the

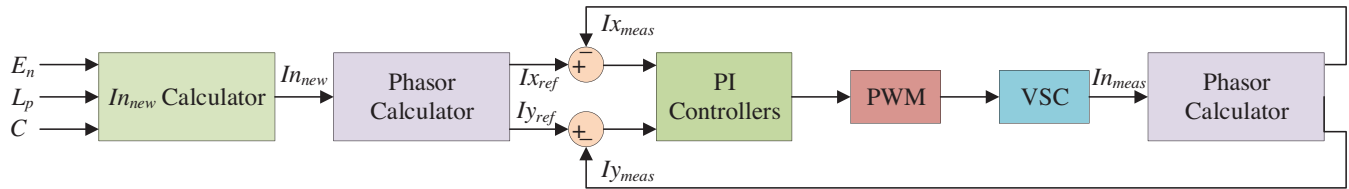

FIGURE 3 A simple single-loop PI controller [30]

RG system using the RCC inverter. In ref. [30], a current injection-based arc suppression principle is employed where the current is injected to the neutral to quickly compensate the active and reactive components of the fault current during an SLG fault. In ref. [30], a single-phase voltage source converter (VSC) is connected to the neutral point of a power substation via a step-up transformer and the residual fault current is estimated using the network parameters (e.g. the network asymmetry factor, network resonance mismatch factor, and network damping factor) which are estimated using the neutral voltage tuning curves. These estimated parameters are then used to estimate the leakage earth resistances (active) and capacitances (reactive) based on which the residual fault current is calculated in a RG distribution during an SLG fault. Figure 3 shows the diagram representation of the control scheme as presented in ref. [30] in which the reference value for the current ($I_{n_{new}}$) that needs to be injected is calculated using the neutral voltage (E_n), the inductance of the Petersen coil (L_p), and shunt capacitance (C). The controlled variable in Figure 3 is the injected current and its error is regulated by PI controllers where the currents are converted into their corresponding phasor values to ensure the compensation of both active and reactive components. The output of the PI controller is used as the reference for the pulse width modulator (PWM) which controls the RCC inverter to output the required injected current. In ref. [30], simulations are performed on a 22 kV power distribution system using MATLAB/Simulink where the RCC inverter suppresses the fault current to 7 A within 30 ms (or 1.5 cycles) and finally to almost zero. The leakage parameters, i.e. the leakage resistances and capacitances are not measured in ref. [30] but estimated using the data from the neutral tuning curves and the performance of the controller heavily relies on these estimated values. Furthermore, it does not consider any phase-locked loop (PLL) which is essential for the proper conversion from the instantaneous value to the phasor.

(c) PI controller with an advanced topology [31]: Another PI controller is proposed in ref. [31] for an ASD with a cascaded H-bridge inverter where two topologies are used to achieve the full compensation of the fault current, reduce the rate of recovery voltage, and resolve the drawbacks of single H-bridge converters (which are bulky in design due to the presence of the large inductor). The topology in ref. [31] allows the converter to be connected either with the neutral point of the system or with each phase of the lines. For the neutral mounted system, the ASD injects the current into the neutral to negate the fault current provoked during an SLG fault (by forcing the fault voltage and current to zero), thus, preventing any arc igni-

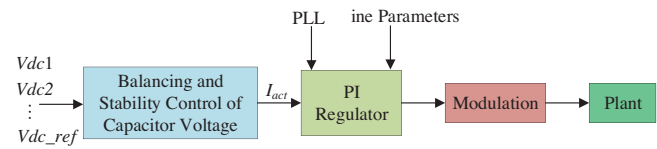

FIGURE 4 A simple single-loop PI controller with an advanced inverter topology [31]

tions. Similarly, when the device is mounted onto lines, each converter in the line would inject compensation current into the system during a fault and the total injected current is the sum of all three phases. Figure 4 shows the control block diagram as presented in ref. [31] in which the reference value of the injected current is calculated using line parameters, i.e. resistor (r) and capacitor (C) along with the zero-sequence voltage while its active component is determined by ensuring the balancing and stability of the capacitor voltage. The PI controller is used to regulate the current so that the fault current can be compensated whereas the modulation block is used to modulate the reference signal to trigger pulses for the cascaded H-Bridge converter for generating the desired current level which will be injected into the neutral or line depending on the topology. Simulations are performed in PSIM/EMTDC platform on a 10 kV system considering both neutral and line-mounted systems by considering the fault impedance as 2 k Ω . In ref. [31], a three-module cascaded H-bridge converter is used (with the DC-link voltage in the neutral mounted system being 3 kV and for the other as 5 kV). The neutral mounted system suppresses the fault current to a value of 10 A within 0.02 s. For the line-mounted system, the fault current is suppressed to 1 A within 0.02 s. For the neutral mounted system, there exists a considerable amount of the residual fault current while the line-mounted system significantly reduces this value. However, the line mounted system utilizes more coils and switches which make it costlier than the neutral-mounted system.

(d) PI controller with an improved modulation technique [22]: An improved PI controller is used in ref. [22] for compensating the fault current in a RG power distribution system using FASD where the compensation is done through a current injection-based approach. In ref. [22], an improved distributed commutations method (IDCM) is used for cascaded H-bridge converter for each phase in a three-phase distribution network. This modulation scheme is used for minimizing the error between the reference and desired values of the injected current during each sampling period to overcome the limitations of existing PI controllers. Here, each H-bridge

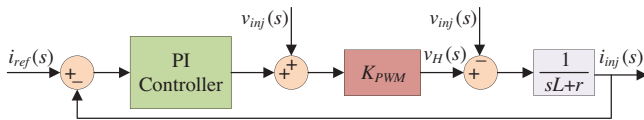

FIGURE 5 A simple single-loop PI controller with an improved modulation technique [22]

in a module is individually controlled during the interval of the sampling rate and if a H-bridge (HB) module fails, this method can circumvent the failure as the HBs are individually sampled for which the next working HB would automatically be traversed. Figure 5 shows the block diagram of the controller adopted in ref. [22] where the reference current ($i_{ref}(s)$) is calculated using the phase-to-ground leakage parameters. The PI controller regulates the error between the reference and the injected current ($i_{inj}(s)$). The regulated error by this converter and the corresponding phase-to-ground voltage ($v_{inj}(s)$) of the injected current is used to generate the input for the pulse width modulator (PWM) which uses the IDCM to produce the output voltage ($v_H(s)$) of the cascaded H-bridge inverter. The difference between $v_H(s)$ and $v_{inj}(s)$ is used to calculate the injected current by utilizing the transfer function of the filter where L and r in Figure 5 represent the filter inductance and resistance, respectively. Simulation results are carried out on 10 kV radial distribution network with the controller in ref. [17] and compared with a similar approach that uses a phase shift carrier PMW (PSCPWM) in order to demonstrate the superiority of the PI controller using the PWM based on the IDCM. Simulation results for the fault impedance between 10 to 100 Ω demonstrate the compensated fault current between 4.14 to 4.67 A while the total harmonic distortion (THD) between 3.48% to 6.29%. These results clearly depict the increase in both compensated current and THD with increases in the fault impedance. Hence, the THD will be unacceptable for high impedance faults while the compensated fault current is sufficient enough to ignite arcs. Furthermore, the approach is used for compensating only the capacitive component of the fault current and the usage of three arc suppression coils makes it more expensive.

3.2.2 | Compound single-loop controllers

An active grounding technique is proposed in ref. [32] for the RG power distribution system where a single-phase voltage source inverter (VSI) is used to compensate the neutral voltage using the combination of PI and PR controllers during an SLG fault. Furthermore, the capacitive current feedback is used to mitigate the overvoltage across the neutral-to-ground due to the asymmetry in distributed parameters as well as a resonance between the inductor of the arc suppression coil and zero-sequence capacitances. The output current of the inverter and neutral-to-ground voltage is used to determine the principle for the overvoltage compensation, i.e. to calculate the reference current that will eliminate the arc. In ref. [32], the PR controller is used to ensure the adequate damping into the system so that the desired steady-state performance (which is

absent in the PI controller for tracking the sinusoidal reference) can easily be achieved and the PI controller helps to achieve the desired stability margin. Hence, the single-loop compound PR+PI controller in ref. [32] exhibits high gain at low frequency and vice-versa. Figure 6 shows the control diagram of the compound control scheme in ref. [32] where the control objective is to regulate the injected current, i.e. $i_o(s)$ by comparing it with the corresponding reference value, $i^*(s)$. In Figure 6, the controller is basically a compound one with the transfer function of both PR and PI controllers. This controller is used to generate the reference voltage ($v_r(s)$) that needs to be compensated based on the feedback of the capacitive current ($i_c(s)$) where the feedback ratio (H_i) is used to adjust the damping into the system by producing the modulation voltage ($v_m(s)$) for the PWM represented by K_{PWM} . Finally, the difference between the output voltage of the VSI and the voltage ($v_c(s)$) across the filter capacitor (C_o) is used to calculate the current through the filter inductor (L_o) where the difference between the filter inductor current and $i_o(s)$ is used to calculate $v_c(s)$. At the end, $i_o(s)$ is calculated based on the current flowing through the shunt impedance network, i.e. the current flowing through the shunt capacitance (C_s) and shunt resistance (R_s). All these can be clearly seen from Figure 6. The performance of this compound controller is evaluated on a 100 kVA laboratory setup where the load is first varied from 0% to 30% of the nominal load and then from 30% to 100%. In ref. [32], the performance of the compound controller is compared with a PI controller and it is found that the neutral voltage is compensated to 21 V with 3% THD in the output current while these values are 42 V and 5.1% with the PI controller. However, the compensation of the fault current is not considered in ref. [32]. Furthermore, the gain parameters used for this controller need to be selected by satisfying some constraints (e.g. dependencies on the crossover frequencies and other parameters of the system).

3.3 | Model-free dual-loop control schemes

The dual-loop control schemes that are used for the compensation of the fault current using the RCC inverter, are similar to that of the structures used for controlling traditional VSIs [33–35]. In these control schemes, an outer voltage control loop is used to generate the reference value of the current that needs to be compensated through the inner current control loop. The dual-loop control structures for the RCC inverter also include simple and compound controllers as discussed in the following.

3.3.1 | Simple dual-loop controllers

In dual-loop simple controllers, each loop uses a single controller to regulate voltage or current so that the desired control objectives can easily be achieved. Different types of controllers used for compensated distribution networks are discussed next.

(a) PI controllers in each loop [36]: A dual-loop control structure is used in ref. [36] for a RG distribution network with

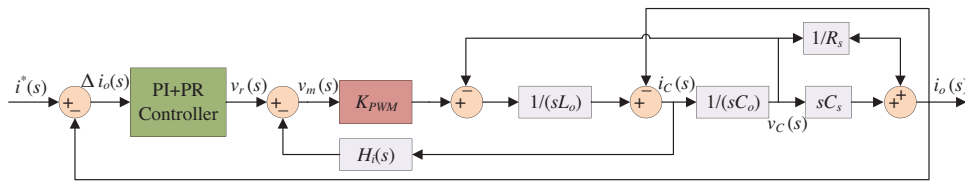

FIGURE 6 A compound single-loop PI+PR controller [32]

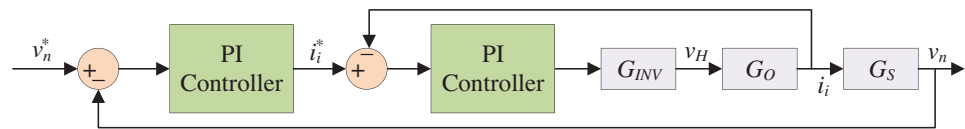

FIGURE 7 A simple dual-loop control scheme with the PI controller in each loop [36]

a single-phase inverter in which PI controllers are employed for both outer and inner loops where the outer loop is used to control the neutral voltage and generate the reference current that needs to be injected by the inverter through the inner control loop. Finally, the inner loop regulates the current using another PI controller to ensure the desired current by the RCC inverter. Here, the main objectives are to inject active, reactive, and harmonic currents to the neutral for reducing the fault current to zero so that arcs can be extinguished effectively. Figure 7 shows the control block diagram of the dual-loop controller where the outer voltage control loop ensures the tracking of the reference neutral voltage (v_n^*) through a controller using the measured value of the neutral voltage (v_n). Here, the neutral voltage is calculated using the relationship between the injected current (i_i) and v_n represented by G_S . The error between v_n^* and v_n is used to determine the reference current (i_i^*) through the PI controller in the outer loop. Finally, the inner loop PI controller is used to generate the switching pulse for the VSI by using the feedback of i_i which can be clearly seen from Figure 7. The performance of this dual-loop controller is evaluated on a low voltage distribution network using the fault impedance as 25Ω where the performance is compared with the RG system having an ASC without any RCC inverter and with the RCC inverter. The results demonstrate that the ASC with the RCC inverter reduces almost 90% of the fault current while this current reduces by 67% with using only the ASC. Furthermore, this controller compensates the harmonics. Though the fault current is compensated faster (i.e. within a quarter cycle of the supply voltage), the performance is analysed for a very low value of the fault impedance while the fault impedance is quite high in RG power distribution systems. Moreover, the controller still suffers from the tracking error as it tracks the sinusoidal reference for the neutral voltage and injected current.

(b) Lag compensator for the outer loop and PI controller for the inner loop [37]: The dual-loop controller in ref. [37] serves similar purposes to that of the controller in ref. [36]. This means the outer loop is for the neutral voltage control and generating the reference current while the inner loop is for controlling the current injection by the RCC inverter. In ref. [37], the

outer loop uses a lag compensator to ensure the desired neutral voltage tracking and generate the reference current whereas the inner loop uses a PI controller for ensuring the desired current injection which can also be seen in Figure 8. Both simulation and experimental studies are conducted to verify the performance of this dual-loop controller where the simulation results are presented in terms of the fault current compensation for the fault impedance between 10 and 100Ω . Simulation results with the dual-loop controller in ref. [37] demonstrate that the RCC inverter compensates the fault current to the value between 0.16 to 0.32 A within 0.08 s. In ref. [37], experimental results are presented in terms of different voltages (i.e. for each phase and neutral) voltage before and after the injection of the current and the significance of these voltages are not clearly discussed. Furthermore, the RG system in ref. [37] uses nonlinear load which will introduce significant harmonics and the effects of harmonics are not analysed.

3.3.2 | Compound dual-loop controllers

The dual-loop compound controllers include more than one controller in at least either outer or inner loop. The dual-loop compound controllers used for compensating the fault current in RG distribution networks are discussed in the following.

(a) PI and PR controllers in the outer loop with a P controller in the inner loop [25]: A compound dual-loop controller is presented in ref. [25] where the outer voltage control loop uses the combination of PI and PR controllers where the PR controller damps the harmonics (mainly, third, fifth, and seventh orders) while the PI controller helps to avoid undesirable peaks. Furthermore, the outer loop controller in ref. [25] enhances the stability margin. The outer loop compound (PI+PR) controller generates the reference current that needs to be injected by the RCC inverter. At the same time, the PI+PR controller ensures the desired tracking of the neutral voltage by settling it down to its reference value as indicated in Figure 9. The inner loop current controller uses the inductor current (i_L) as the feedback for the P controller which generates

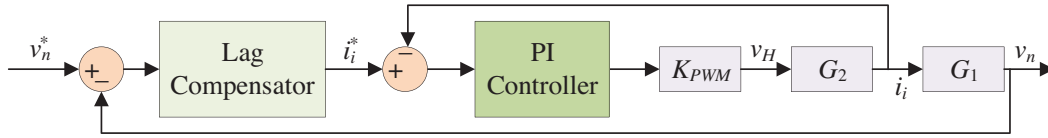

FIGURE 8 A simple dual-loop control scheme with a lag compensator and PI controller in outer and inner loops, respectively [37]

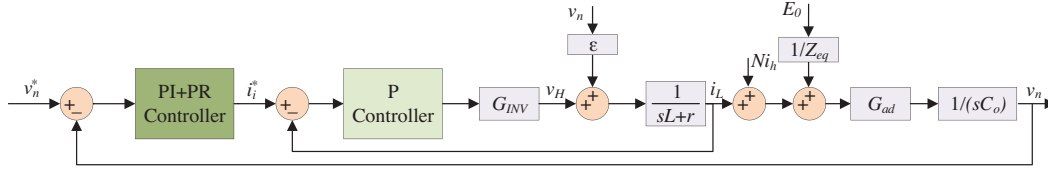

FIGURE 9 A compound dual-loop control scheme with PI+PR and P controller in outer and inner loops, respectively [25]

the switching pulses for the inverter as shown in Figure 9. The values of i_L and v_n are determined using the power conditioning stage as indicated in Figure 9. The performance of the controller is evaluated through an experimental study using a 380 V test network where the fault impedances are considered as 100 Ω and 10 k Ω . The results are demonstrated only in terms of the faulty phase voltage compensation where it is found that this faulty phase voltage reduces to 15 V within 5 ms when the fault impedance is 10 k Ω . On the other hand, the faulty phase voltage is 5 V for 100 Ω fault impedance. Though the controller in ref. [25] avoids the capacitive current measurement, it still suffers from the reliability issue.

(b) PI controllers with the hysteresis control scheme [38]: A dual-loop compound controller is presented in ref. [38] for RG distribution systems using an electromagnetic hybrid Petersen coil (EHPC) that comprises a magnetically controlled reactor (MCR) and an active power compensator (APC). The EHPC works based on two operating modes which are associated with normal and fault conditions. During the normal operating condition, the reactance ($X_{Lm}^1 \approx X_{Lm}^{\text{ref}}$) of the MCR is matched with the total zero-sequence capacitive reactance ($1/(\omega C_0)$) at the substation where this reactance is adjusted by controlling the DC excitation current (I_{dc}) based on the desired value of the zero-sequence voltage (v_{0-rms}). When an SLG fault occurs, the angle difference between the faulty phase (which is Phase C in ref. [38]) voltage (v_C) and zero sequence voltage (v_0) is used to determine the reactance ($X_{Lm}^2 \approx X_{Lm}^{\text{ref}}$) of the MCR as demonstrated in Figure 10. The MCR works based on an open-loop control structure using the relationship between the output of the APC (v_{ac}) and I_{dc} , i.e. $X = f(v_{ac}, I_{dc})$ which can also be found from Figure 10. During the SLG fault, the APC comes into operation for suppressing the recovery voltage of the faulty phase and compensating the fault current. In ref. [38], two separate PI controllers are used in the outer loop (which can also be seen in Figure 10): one is to ensure the compensation of the faulty phase voltage and the other one is to compensate the fault current including the harmonics. Here, the first PI controller regulates the rms value of the injected current (I_{i-rms}) whose reference value

($I_{R-rms}^{\text{ref}(1)}$) is calculated using the rms value of v_0 , i.e. v_{0-rms} and zero-sequence resistance (R_0). Finally, the instantaneous value of the injected reference current ($i_R^{\text{ref}(1)} \approx i_i^{\text{ref}}$) is calculated by multiplying $\sin(\omega t_2)$ as shown in Figure 10. Similarly, the second PI controller regulates the difference of the rms value of v_C , i.e. v_{C-rms} and v_{0-rms} to determine the reference current ($I_{R-rms}^{\text{ref}(2)}$) whose the instantaneous value ($i_R^{\text{ref}(1)}$) is also calculated by multiplying $\sin(\omega t_2)$ and the harmonic component (i_{0jh}) is also incorporated. On the other hand, the inner loop includes a hysteresis controller for the current source inverter to ensure the desired current injection to the neutral point. The performance of the compound controller in ref. [38] is evaluated using both simulation and experimental results. Simulation studies are carried out in EMTDC/PSCAD platform on a 10.5 kV system by considering the fault impedance as 65 Ω and the result shows that the dual-loop compound controller in ref. [38] reduces the fault current to 0.6 A. On the other hand, the experimental studies mainly stress the measurement of parameters and the compensation of the fault current is considered by considering the fault impedance as 5 Ω for a 380 V three-phase four-wire system. However, the experimental results do not include the compensated value of the fault current. Furthermore, the hysteresis controller requires variable switching frequency which complicates the harmonic compensation.

The performance of these model-free controllers has been further improved by model-based controllers as discussed in the following subsections.

3.4 | Model-based linear controller

Unlike PI controllers as discussed previously in single- and dual-loop control structure, model-based controllers are designed using the dynamic model of ASDs. The model-based controllers ensure better performance as compared to those model-free controllers. The existing literature includes two model-based control techniques: H-infinity and finite

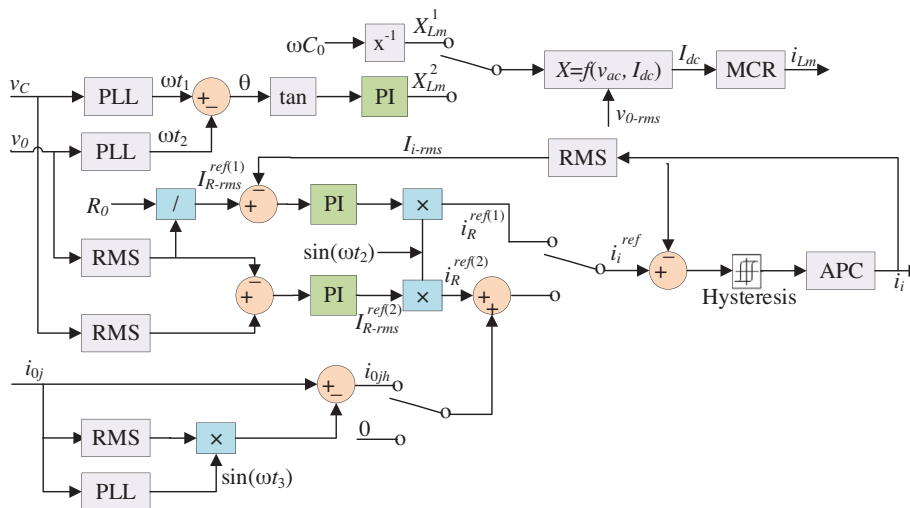

FIGURE 10 A compound dual-loop control scheme with PI controllers in the outer loop and hysteresis controller in the inner loops [38]

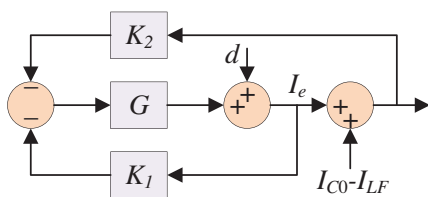

FIGURE 11 A H-infinity control scheme for the RCC inverter [39]

control set model predictive methods as discussed in the following.

(a) **H-infinity control scheme [39]:** A H-infinity control scheme is implemented in ref. [39] with a new arc suppression coil using the active filter technology in which the ASD comprises the two main parts: the principal part with a tap adjusting arc suppression coil (responsible for reactive fault current compensation) and an auxiliary coil connected in parallel comprising a single-phase voltage source inverter (responsible for active and harmonic fault current compensation). The device has a combination of two operating modes: the pre-and follow-setting modes. When the system is healthy, the ASD is set for 15% over-compensation and shifts to the follow-setting mode as soon as a fault occurs. This improved technique is capable to avoid mismatches due to the tuning in traditional Petersen coils. Figure 11 shows the block diagram representation of the H-infinity control scheme in which the control objective is the current (I_e) at the fault point and the control input (u) is expressed as the voltage difference between the average voltages of the auxiliary coil and faulty phase. In Figure 11, G demonstrates the relationship between the control input (u) and the fault current (I_e) while d is used to represent as an additive disturbance. The controlled output current is used to suppress the fault current where K_1 and K_2 are used as the regulator. The control system toolbox in MATLAB is used to calculate K_1 and K_2 whereas the Gram Matrix is used to reduce the total order of the regulator from seventeen to seven in order to ensure the satisfactory per-

formance. Simulations are carried out using PSCAD/EMTDC for a 10 kVA system. For the comparison, a fault compensation scenario is simulated without the operation of the auxiliary coil to compare it with the operation of the auxiliary coil. The results show that without the operation of the auxiliary coil, the current at the fault location is about 2 A as the compensation here was done only by the principal coil. Once the auxiliary coil was activated, it is rapidly reduced to 0.2 A. However, the order of the controller is still too high while considering the original order of the system and thus, it increases the computation burden.

(b) **Finite control set model predictive control scheme [27]:** The approach in ref. [27] utilizes an improved flexible ASD (FASD) which is the three-phase cascaded H-Bridge (CHB) converter with auxiliary sources incorporating an improved finite set model predictive control method. The objective here is to achieve the full fault current compensation while eliminating the common limitations of reliability of most converters. From the control perspective, the objective in ref. [27] is to overcome the limitations of the traditional finite control set model predictive controller (FCS-MPC), i.e. the computational efforts for the large number of H-bridge (HB), high sampling frequency or prediction horizon, and use of only one voltage level causing the steady-state error issue. The method in ref. [27] delves into an augmented cascaded H-Bridge (CHB) converter, a two-voltage level model predictive controller (2V-MPC) for the CHB converter. The CHB converter has an auxiliary source installed for each H-Bridge module consisting of an AC supply with an uncontrolled rectifier. This auxiliary source is connected to the DC-side during an SLG fault which enhances the stability of the DC voltage that is important to ensure steady-state operation during the arc suppression. The new 2V-MPC, used to control the CHB converter, uses the combination of two optimal voltage levels (from previous and present periods) during a sampling period to reduce the steady-state error along with the reduction in the sampling frequency. A novel switching scheme for the CHB converter is also proposed to achieve a balanced switching transition among HB cells.

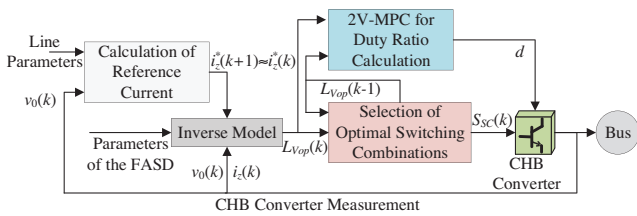

FIGURE 12 A finite control set model predictive control scheme for the RCC inverter [27]

Figure 12 shows the block diagram for the 2V-MPC from where it can be seen that the line parameters and output voltage (v_0) are used to compute the predicted value of the reference, i.e. $i_{\zeta}^*(k+1) \approx i_{\zeta}^*(k)$. As shown in Figure 12, an inverse model is then used to generate the voltage level at the current stage, i.e. $L_{Vop}(k)$ using $i_{\zeta}^*(k+1) \approx i_{\zeta}^*(k)$, parameters of the FASD, output voltage, and injected current by the CHB converter during the k th sampling period. The voltage level from the previous $k-1$ sampling period, i.e. $L_{Vop}(k-1)$ and $L_{Vop}(k)$ are finally used to select the optimal switching combination, i.e. $S_{SC}(k)$ and duty ratio, i.e. d for the current sampling period. Simulations are performed in MATLAB/Simulink for a 10 kV distribution network with various fault resistances ranging from 10 to 1000 Ω that represent both low and high impedance faults. The earth fault is simulated at $t = 0.04$ s while the FASD is activated at 0.1 s to clearly see the changes in the waveforms. For the fault resistance of 10 Ω , the fault current drops from 40.1 to 3.1 A once the FASD started and the faulty phase voltage is nearly suppressed to zero, thereby, eliminating the chance of an arc rekindling. For 100 and 1000 Ω fault resistances; the residual fault current is lower than for 10 Ω as the fault impedances are much higher. The performance of this 2V-MPC is compared with that of the traditional FCS-MPC. The steady-state error of the fault current for the FCS-MPC was 5.89% while the 2V-MPC achieves a lower error of 3.43%, thereby, consolidating the fact that the 2V-MPC method can attain a lower steady-state error than the FCS-MPC. The 2V-MPC requires a higher switching frequency than FCS-MPC, thereby, achieving a finer tuning of current to obtain better accuracy. However, the switching losses will be significant due to the high switching frequency.

These model-based linear controllers have a limited operating region in terms of compensating the fault current while the fault current varies over a large range. Hence, these controllers do not ensure that operations are independent of operating points.

3.5 | Model-based nonlinear controllers

Nonlinear controllers are capable to ensure the operation of ASDs that will be independent of operating points. It is essential to design nonlinear controllers for ASDs due to the nonlinear, non-periodic, and stochastic characteristics of the fault current. Though different types of nonlinear controllers are used in different power system applications ranging from the excitation control [41] to converter control [42], only the nonlinear backstepping controller (BSC) is used to design a controller for the

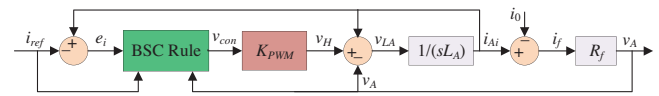

FIGURE 13 A nonlinear backstepping control scheme for the RCC inverter [40]

RCC inverter. A nonlinear BSC is designed in ref. [40] for a FASD using the current-based arc suppression principle where the current is injected into the system rather than the neutral point. In ref. [40], a three-phase ASD is directly connected to the bus bar and the FASDs in different phases are activated depending on the fault on phases. For example, the FASD on Phase A will be activated if the SLG fault occurs on this phase. Figure 13 shows the control block diagram for the backstepping controller in ref. [40] where the main target is to ensure the desired tracking of the reference current (i_{ref}) by injecting the current (i_A) through the FASD connected to Phase A as the fault is considered on this phase. However, the connection of the FASD is not a usual practice and a single-phase FASD connected between the neutral and ground is sufficient to compensate the fault current due to the SLG fault.

Another nonlinear BSC is presented in ref. [28] which is designed for a single-phase FASD where this FASD is connected between the neutral and ground. This control technique is exactly similar to that as presented in ref. [40] and also used for compensating the fault current (both active and reactive components) due to SLG faults. The only difference for the control approach in ref. [28] while comparing with ref. [40] is that it uses a second-order generalized integrator phase-locked loop (SOGI-PLL) for calculating the reference current. Analytically, the reference current for compensating the fault current in ref. [28] includes differential terms of the line-to-neutral voltage related to the faulty phase which is susceptible to disturbances in the neutral and faulty phase-to-ground voltages. The SOGI-PLL is used to acquire the amplitude and angle of the line-to-neutral voltage. Simulation results in ref. [28] clearly demonstrate that the traditional BSC without using the SOGI-PLL, particularly during low fault resistances, exhibits a considerable amount of the residual current owing to the disturbances in the neutral voltage and line-to-neutral voltage for the faulty phase. Hence, the calculation of the reference current experiences significant perturbations. On the other hand, the improved BSC based on the SOGI-PLL demonstrates much better performance even for lower resistances by significantly compensating the fault current. Therefore, the FASD with the BSC based on the SOGI-PLL provides better arc extinguishing performance while comparing with the traditional BSC including higher current rejection ratios. A nonlinear backstepping approach is used in ref. [43] which does not require to utilize any SOGI-PLL as indicated in ref. [28]. However, these backstepping approaches are not robust against disturbances. The sliding controllers with different types of sliding surfaces are presented in refs. [44–47] where the main focuses are to improve the chattering effects and increase the speed of compensating the fault current. However, there are still scopes for the improvement

TABLE 1 Summary of different control schemes used for compensating the fault current and/or faulty phase voltage due to the SLG fault in RG power distribution networks

Control scheme	Control structure	Configuration of the ASD	Connection point	Results	Fault impedance	Compensated fault current	Compensated faulty phase voltage
Closed-loop [29]	SSL	1- ϕ	N2G	S	50 Ω to 2 k Ω	0.067 A to 0.026 A	3.4 V to 50.2 V
PI [30]	SSL	1- ϕ	N2G	S	50 Ω	7 A (within 30 ms)	–
PI+Advanced	SSL	1- ϕ (neutral-mounted)	N2G (1- ϕ) &	S	2 k Ω	7 A (1- ϕ) &	–
Topology [31]		3- ϕ (line-mounted)	B2G (3- ϕ)			1 A (3- ϕ)	
PI+Advanced Modulation [22]	SSL	Three 1- ϕ	B2G	S & E	10 Ω to 100 Ω	4.14 A to 4.67 A	–
PR+PI [32]	CSL	1- ϕ	B2G	E	Load variation	–	21 V
PI and PI [36]	SDL	1- ϕ	N2G	S	25 Ω	0.006 A (fundamental) 0.00001 A (harmonic)	0.16 V (fundamental) 0.0002 V (harmonic)
Lag and PI [37]	SDL	1- ϕ	N2G	S & E	10 Ω to 100 Ω	0.16 A to 0.32 A	–
PI+PR and P [25]	CDL	1- ϕ	N2G	E	100 Ω to 10 k Ω	–	5 V to 15 V
Multiple PI and hysteresis [38]	CDL	1- ϕ	N2G	S & E	65 Ω	0.6 A	–
H-infinity [39]	LMB	1- ϕ	N2G	S		0.2 A	–
FC-MPC [27]	LMB	Three 1- ϕ	B2G	S & E	10 Ω to 1 k Ω	≤ 3.1 A	–
BSC [40]	NMB	3- ϕ	B2G	S & E	1 Ω to 100 Ω	<1.7 A	–
BSC [28]	NMB	1- ϕ	N2G	S & E	1 Ω to 1 k Ω	2.6 A to 0.06 A	–

3.6 | Summary of all control schemes

The summary of all controllers used for the compensation of the fault current and/or faulty phase voltage in RG power distribution networks due to the SLG fault are shown in Table 1. The summary of these controllers in this table are provided in terms of the control scheme, control structure, configuration of the ASD (single- or three-phase, i.e. 1- ϕ or 3- ϕ), connection point (e.g. between neutral or bus to the ground, i.e. N2G or B2G), results (simulation (S)/experiment (E)), fault impedance, and compensated values of the fault current including the faulty phase voltage where available. In Table 1, simple single-loop, compound single-loop, simple dual-loop, compound dual-loop, linear model-based, and nonlinear model-based are denoted as SSL, CSL, SDL, CDL, LMB, and NMB respectively. Table 1 shows the qualitative comparison though there are some quantitative aspects. As per the regulatory framework in ref. [4], all these quantitative aspects are independent of the network structure. For this reason, it is fair to compare different networks with different controllers.

3.7 | Implementation costs of different controllers

From the classification as shown in Figure 2 and the discussions presented for different controllers, it can be seen that the model-

free controller with single-loop configuration with the simple structures are the easiest to implement as these controllers work based only one approach. The level of complexities for these single-loop controllers slightly increases when compound control approaches are used. The reason behind such complexities is the utilization of more than one method. The model-free controllers becomes more complicated when an additional loop is used. Though these dual-loop model-free controllers offer two-degree freedoms, the compound structure becomes even more complicated than the simple one due to the similar reason as mentioned for the single-loop controller. However, the performance guarantee of these model-free controllers highly relies on the experience of the designer as the desired control performance can be achieved if and only if the gain parameters are selected precisely. Hence, the implementation process is simple and associated computational cost is low.

On contrary, model-based approaches follow a systematic way to determine the control parameters. The linear model-based controllers for REFCLs are designed using linearized models. The difficulties with these linear model-based controllers is the overall order of the system as the order of the controller usually equals to at least the order of the system. The complexities in the calculation increases with the nonlinear model-based controllers. However, all these calculations can be carried out offline and only the final control law for the nonlinear controller can be implemented to achieve the desired performance. From this perspective, the implementation cost

would not be a burden for nonlinear model-based controllers used in REFCLs.

Based on the performance summary of different existing fault current compensation techniques used for RG power distribution networks, the gaps and challenges in light of extinguishing powerline bushfires due to the SLG faults are discussed in the following section.

4 | CHALLENGES

The existing fault current compensation techniques through the RCC inverters in RG power distribution systems mostly aim to reduce the fault current due to SLG faults. The Regulatory Impact Statement [4] clearly mentioned that it is essential to maintain both fault current and faulty phase voltage to a certain limit within a specific timeframe in order to extinguish the arc in REFCL compensated distribution networks due to SLG faults. For both low impedance (typically, equal to or lower than 1 k Ω) and high impedance (generally, higher than 1 k Ω), the fault current needs to be maintained at 0.5 A within 2 s after the fault inception [4]. Furthermore, the faulty phase voltage needs to be observed at 85 ms, 0.5 s, and 2 s for low impedance fault where this voltage needs to be maintained at 1,900 V, 750 V, and 250 V, respectively [4]. On the other hand, this faulty phase voltage needs to be maintained at 250 V within 2 s for high impedance faults [4]. These operational criteria have further been verified through experimental results. The challenges associated with fault compensations in RG power distribution systems in terms of mitigating powerline bushfires are highlighted through the following key points:

- The model-free control schemes do not capture the actual behaviours of REFCLs in RG power distribution networks while the performance of any controller depends on the information of the system.
- The single-loop controllers are mainly designed using the PI control scheme where these PI controllers are used to track the sinusoidal reference which exhibits some tracking errors and hence, the full compensation cannot be achieved. Furthermore, these controllers provide slower responses.
- The implementation of single-loop controllers involves complexities in determining the reference that needs to be tracked.
- The dual-loop controllers ensure better performance in terms of simplifying the reference calculation. However, these controllers are still used to track sinusoidal references.
- The model-based controllers seem to be more effective, however, their operations are limited to a specific set of operating points.
- Nonlinear model-based controllers are independent of operating points but the existing controllers are designed using very simple models and do not guarantee the compensation of both fault current and faulty phase voltage.
- The methods covered for compensating the fault in RG distribution systems do not consider the reduction of the fault current and faulty phase voltage as per the operational guidelines as indicated in [4]. Furthermore, these methods mostly

consider the compensation of the fault current though there are only a few techniques which consider either only faulty phase voltage or both fault current and faulty phase voltage.

- Most of the existing techniques cover the compensation of the active and reactive components of the fault current with less emphasis on the harmonics due to nonlinear loads (though a few methods talk about this issue). However, the harmonics may cause a significant current that could be sufficient to ignite bushfires.
- There are chances of series resonances during normal conditions which may lead to overvoltages where sustained overvoltages may cause equipment failures and ignite fires that are commonly known as cross-country faults [23].
- Despite suppressing the faulty phase voltage to zero, there might be some situations where sufficient voltage and current may appear at the fault point due to the line voltage drop which makes it difficult to prevent the arc ignition. Hence, it is essential to consider these factors during the system modelling.
- The performances of existing techniques are mostly analysed using low impedance faults while RG power distribution networks experience high impedance faults. Therefore, the results do not provide much insight for high impedance faults that are common in practical systems.
- The effects of network imbalances are not considered during the system modelling and controller design process though the small variations in such imbalances severely affect the performance of the controller.
- The nominal values of the inductance for the ASC, zero-sequence resistance, and zero-sequence capacitance are used during the implementation of existing controllers. However, the values of these parameters change during the practical operation of the system. For example, the leakage current relies on the zero-sequence resistance whose value depends on the atmospheric conditions.
- All these existing methods do not consider the effects of distributed energy resources based on the renewable power generation. It would be more challenging to deal with REFCL compensated distribution networks with distributed energy resources.

It is significantly important to overcome these challenges in order to utilize the full benefits of REFCLs in RG power distribution networks as well as to effectively compensate SLGs faults for mitigating powerline bushfires.

5 | CONCLUSIONS AND FUTURE DIRECTIONS

This paper provides a comprehensive overview of different control techniques adopted by residual current compensation inverters for the fault current compensation in resonant grounded distribution networks to mitigate powerline bushfires. Furthermore, the detailed analyses on major grounding techniques are covered before critically analysing different control schemes as these play a key role in the fault compensation. For the sake of providing a comprehensive analysis, the

control schemes for residual current compensation inverters are classified as model-free and model-based schemes where model-free controllers include single- and dual-loop structures while model-based schemes are categorized as linear and non-linear controllers. Furthermore, both single- and dual-loop structures are divided into simple and compound configurations. The analysis presents that the dual-loop controllers outperform single-loop whereas compound configurations are used to achieve better performance than simple configurations. On the contrary, model-based controllers are more realistic in terms of achieving the desired fault compensation though linear model-based controllers are restricted to small operating regions. Nonlinear controllers for the residual current compensation inverter ensure unrestricted operating regions, however, these controllers are not extensively used. Furthermore, all these controllers are mainly used to reduce the fault current without following the performance guidelines for reducing the fault current to a level so that powerline bushfires can be mitigated. The following key points can be considered as the future directions for the research in order to compensate the fault current for mitigating powerline bushfires:

- The detailed dynamic model of the arc suppression device needs to be developed so that the controller can be designed to compensate both fault current and faulty phase voltage.
- A new type of nonlinear control scheme should be designed and implemented that will have the ability to fully compensate the fault current including the harmonic components.
- The effects of network imbalance needs to be considered during the controller design process.
- The controller needs to be robust against changes in operating conditions, model uncertainties, and parametric uncertainties.
- The controllers' performance needs to be analysed for both high and low impedance faults while following the operational guideline for mitigating powerline bushfires.
- The controller needs to be designed by considering the effects of distributed energy resources in distribution networks.

AUTHOR CONTRIBUTIONS

Warnakulasuriya Sonal Prashenajith Fernando: Conceptualization, formal analysis, investigation, resources, software, validation, visualization, writing - original draft, writing - review and editing. Md Apel Mahmud: Conceptualization, project administration, resources, supervision, validation, writing - original draft, writing - review and editing. Shama Naz Islam: Resources, supervision, writing - original draft, writing - review and editing. Md Abdul Barik: Investigation, resources, supervision, writing - review and editing. Nasser Hosseinzadeh: Resources, supervision, writing - original draft, writing - review and editing.

ACKNOWLEDGEMENT

The authors would like to thank Deakin University in Australia as a part of this work was carried out during their tenure at Deakin.

CONFLICT OF INTEREST

The authors declare no conflict of interest.

DATA AVAILABILITY STATEMENT

The data that support the findings of this study are available on request from the corresponding author. The data are not publicly available due to privacy or ethical restrictions.

ORCID

Md.Apel Mahmud  <https://orcid.org/0000-0002-5302-5338>

REFERENCES

1. Orton, T.: Powerline Bushfire Safety Taskforce: Final Report. Energy Safe Victoria, Collins St West, Victoria (2011)
2. Teague, B., McLeod, R., Pascoe, S.: Victorian Bushfires Royal Commission. Parliament of Victoria, East Melbourne, Victoria (2009)
3. Coldham, D., Czerwinski, A., Marxsen, T.: Probability of bushfire ignition from electric arc faults. Energy Safe Victoria, Collins St West, Victoria (2011)
4. Acil Allen Consulting Pty Ltd: Regulatory impact statement: Bushfire mitigation regulations amendment. Department of Economic Development, Jobs, Transport and Resources, Victoria (2015)
5. Roberts, J., Altuve, H.J., Hou, D.: Review of ground fault protection methods for grounded ungrounded and compensated distribution systems. In: 27th Annual Western Protective Relay Conference, pp. 1–40. Washington State University, Pullman, WA (2001)
6. Thomas, E.S., Barber, R.A., Dagenhart, J.B., Clapp, A.L.: Distribution system grounding fundamentals. In: Rural Electric Power Conference, pp. A2–1. IEEE, Piscataway, NJ (2004)
7. Ramamoorthy, M., Narayanan, M.M.B., Parameswaran, S., Mukhedkar, D.: Transient performance of grounding grids. IEEE Trans. Power Delivery 4(4), 2053–2059 (1989)
8. Gross, E.T.B., Chitnis, B.V., Stratton, L.J.: Grounding grids for high-voltage stations. Trans. Am. Inst. Electr. Eng. Part 3 72(4), 799–810 (1953)
9. : IEEE Recommended Practice for System Grounding of Industrial and Commercial Power Systems. IEEE Std 30031-2019, pp. 1–79. IEEE, Piscataway, NJ (2019)
10. Hanninen, S., Lehtonen, M.: Characteristics of earth faults in electrical distribution networks with high impedance earthing. Electr. Power Syst. Res. 44(3), 155–161 (1998)
11. Jacob, D., Nithiyanthan, K.: A decentralized fault detection technique for detecting single phase to ground faults in power distribution systems with resonant grounding. WSEAS Trans. Bus. Econ. 5(5), 151–160 (2008)
12. Winter, K.M.: The rcc ground fault neutralizer – a novel scheme for fast earth-fault protection. In: CIRED 2005-18th International Conference and Exhibition on Electricity Distribution, pp. 1–4. IEEE, Piscataway, NJ (2005)
13. Khunkhun, K.J.S., Koepfinger, J.L., Haddad, M.V.: Resonant grounding (ground fault neutralizer) of a unit connected generator. IEEE Trans. Power Apparatus Syst. 96(2), 550–559 (1977)
14. Liu, K., Zhang, S., Li, B., Zhang, C., Liu, B., Jin, H., et al.: Flexible grounding system for single-phase to ground faults in distribution networks: a systematic review of developments. IEEE Trans. Power Delivery 37(3), 1640–1649 (2022)
15. Fickert, L., Achleitner, G., Schmutzner, E., Obkircher, C., Raunig, C.: In: CIRED 2009-20th International Conference and Exhibition on Electricity Distribution, pp. 1–4. IEEE, Piscataway, NJ (2009)
16. Parise, G., Gatta, F.M., Lauria, S.: Common grounding system. In: IEEE Systems Technical Conference on Industrial and Commercial Power. pp. 184–190. IEEE, Piscataway, NJ (2005)
17. Komrska, T., Glac, A., Talla, J., Skala, B., Stepanek, J., Streit, L., et al.: Ground fault active compensation in emulated distribution grid of 10 kV. In: 2020 22nd European Conference on Power Electronics and Applications, pp. P1–P6. IEEE, Piscataway, NJ (2020)

18. Wang, X., Gao, J., Wei, X., Zeng, Z., Wei, Y., Kheshti, M.: Single line to ground fault detection in a non-effectively grounded distribution network. *IEEE Trans. Power Delivery* 33(6), 3173–3186 (2018)
19. Gouda, O.E.S.: Design Parameters of Electrical Network Grounding Systems. IGI Global, Hershey, PA (2018)
20. Barik, M.A., Gargoom, A., Mahmud, M.A., Haque, M.E., Al-Khalidi, H., Than Oo, A.M.: A decentralized fault detection technique for detecting single phase to ground faults in power distribution systems with resonant grounding. *IEEE Trans. Power Delivery* 33(5), 2462–2473 (2018)
21. Song, Y., Yuan, S., Zhao, C., Jia, Y.: Analysis and selection of neutral grounding modes in cable distribution network. In: 2007 International Conference on Power Engineering, Energy and Electrical Drives, pp. 518–521. IEEE, Piscataway, NJ (2007)
22. Zheng, Z.Y., Guo, M.F., Yang, N.C., Jin, T.: Flexible arc-suppression method based on improved distributed commutations modulation for distribution networks. *Int. J. Electr. Power Energy Syst.* 116, 105580 (2020)
23. Burgess, R., Ahfcock, A.: Minimising the risk of cross-country faults in systems using arc suppression coils. *IET Gener. Transm. Distrib.* 5(7), 703–711 (2011)
24. Mitolo, M., Musca, R., Tartaglia, M., Zizzo, G.: Electrical safety analysis in the presence of resonant grounding neutral. *IEEE Trans. Ind. Appl.* 55(5), 4483–4489 (2019)
25. Wang, W., Zeng, X., Yan, L., Xu, X., Guerrero, J.M.: Principle and control design of active ground-fault arc suppression device for full compensation of ground current. *IEEE Trans. Ind. Electron.* 64(6), 4561–4570 (2017)
26. Janssen, M., Kraemer, S., Schmidt, R., Winter, K.: Residual current compensation (RCC) for resonant grounded transmission systems using high performance voltage source inverter. In: 2003 IEEE PES Transmission and Distribution Conference and Exposition, pp. 574–578. IEEE, Piscataway, NJ (2003)
27. Qiu, W., Guo, M., Yang, G., Zheng, Z.: Model-predictive-control-based flexible arc-suppression method for earth fault in distribution networks. *IEEE Access* 7, (2019)
28. Zheng, Z.Y., Guo, M.F., Yang, N.C., Jin, T.: Single-phase flexible arc suppression device based on BSC-SOGI-PLL method for distribution networks. *Int. J. Electr. Power Energy Syst.* 121, 106100 (2020)
29. Qi, M., Leng, H., Zhang, Z., Yang, L., Peng, S., Zeng, X.: Fast disposal method for reducing electricity risk of single-phase ground fault in distribution network. In: 2017 China International Electrical and Energy Conference (CIEEC), pp. 554–558. IEEE, Piscataway, NJ (2017)
30. Gargoom, A., Barik, M.A., Mahmud, M.A., Haque, M.E., Oo, A.M.T., Al-Khalidi, H., et al.: Residual current compensator based on voltage source converter for compensated distribution networks. In: 2018 IEEE Power Energy Society General Meeting (PESGM), pp. 1–5. IEEE, Piscataway, NJ (2018)
31. Wang, F., Guo, M., Yang, G.: Novel arc-suppression methods based on cascaded H-bridge converter. In: 2016 Asia-Pacific International Symposium on Electromagnetic Compatibility (APEMC), pp. 691–694. IEEE, Piscataway, NJ (2016)
32. Wang, W., Yan, L., Zeng, X., Fan, B., Guerrero, J.M.: Principle and design of a single-phase inverter-based grounding system for neutral-to-ground voltage compensation in distribution networks. *IEEE Trans. Ind. Electron.* 64(2), 1204–1213 (2017)
33. Barzegar-Kalashani, M., Tousi, B., Mahmud, M.A., Farhadi-Kangarlou, M.: Non-linear integral higher-order sliding mode controller design for islanded operations of T-type three-phase inverter-interfaced distributed energy resources. *IET Gener. Transm. Distrib.* 14(1), 53–61 (2020)
34. Roy, T.K., Mahmud, M.A.: Active power control of three-phase grid-connected solar PV systems using a robust nonlinear adaptive backstepping approach. *Solar Energy* 153, 64–76 (2017)
35. Mahmud, M.A., Pota, H.R., Hossain, M.J.: Dynamic stability of three-phase grid-connected photovoltaic system using zero dynamic design approach. *IEEE J. Photovoltaics* 2(4), 564–571 (2012)
36. Wen, W., Yan, L., Fan, B., Zeng, X.: Control method of an arc suppression device based on single-phase inverter. In: 2016 International Symposium on Power Electronics, Electrical Drives, Automation and Motion (SPEEDAM), pp. 929–934. IEEE, Piscataway, NJ (2016)
37. Chen, D., Zeng, X., Peng, S., Wang, Y., Wang, Y., Zhao, Y., et al.: Active inverter device with double closed loop control method for arc suppression in distribution network. In: 2017 China International Electrical and Energy Conference (CIEEC), pp. 549–553. IEEE, Piscataway, NJ (2017)
38. Wang, P., Chen, B., Tian, C., Sun, B., Zhou, M., Yuan, J.: A novel neutral electromagnetic hybrid flexible grounding method in distribution networks. *IEEE Trans. Power Delivery* 32(3), 1350–1358 (2017)
39. Qu, Y., Tan, W., Yang, Y.: H-infinity control theory apply to new type arc-suppression coil system. In: 2007 7th International Conference on Power Electronics and Drive Systems, pp. 1753–1757. IEEE, Piscataway, NJ (2007)
40. Zheng, Z., Guo, M., Yang, N., Jin, T.: FASD based on BSC method for distribution networks. *IET Gener. Transm. Distrib.* 13(24), 5487–5494 (2019)
41. Roy, T.K., Mahmud, M.A., Oo, A.M.T.: Robust adaptive backstepping excitation controller design for higher-order models of synchronous generators in multimachine power systems. *IEEE Trans. Power Syst.* 34(1), 40–51 (2019)
42. Mahmud, M.A., Roy, T.K., Saha, S., Haque, M.E., Pota, H.R.: Robust nonlinear adaptive feedback linearizing decentralized controller design for islanded dc microgrids. *IEEE Trans. Ind. Appl.* 55(5), 5343–5352 (2019)
43. Roy, T.K., Mahmud, M.A., Barik, M.A., Nasiruzzaman, A.B.M., Oo, A.M.T.: A nonlinear backstepping control scheme for rapid earth fault current limiters in resonant grounded power distribution systems: applications for mitigating powerline bushfires. *IEEE J. Emerg. Sel. Top. Ind. Electron.* 3(2), 362–371 (2021)
44. Barzegar-Kalashani, M., Mahmud, M.A., Barik, M.A., Oo, A.M.T.: Control of arc suppression devices in compensated power distribution systems using an integral sliding mode controller for mitigating powerline bushfires. *Int. J. Electr. Power Energy Syst.* 134, 107481 (2022)
45. Roy, T.K., Mahmud, M.A., Ghosh, S.K., Pramanik, M.A.H., Kumar, R., Oo, A.M.T.: Design of an adaptive sliding mode controller for rapid earth fault current limiters in resonant grounded distribution networks to mitigate powerline bushfires. In: 2021 IEEE Texas Power and Energy Conference (TPEC), pp. 1–6. IEEE, Piscataway, NJ (2021)
46. Roy, T.K., Mahmud, M.A.: Fault current compensations in resonant grounded distribution systems to mitigate powerline bushfires using a non-singular terminal sliding mode controller. *IET Gener. Transm. Distrib.* 16(3), 479–491 (2022)
47. Roy, T.K., Mahmud, M.A., Nasiruzzaman, A.B.M., Barik, M.A., Oo, A.M.T.: A non-singular fast terminal sliding mode control scheme for residual current compensation inverters in compensated distribution networks to mitigate powerline bushfires. *IET Gener. Transm. Distrib.* 15(9), 1421–1434 (2021)

How to cite this article: Fernando, W.S.P., Mahmud, M.A., Islam, S.N., Barik, M.A., Hosseinzadeh, N.: A comprehensive review of control techniques for compensating the fault current in resonant grounded distribution networks: From the perspective of mitigating powerline bushfires. *IET Gener. Transm. Distrib.* 1–16 (2022).

<https://doi.org/10.1049/gtd2.12678>